



Dear Correct Craft Owner,

Welcome to the Nautique Family! For 79 years, Correct Craft has been dedicated to providing our customers and their families with the finest inboard boats available. It's our passion to create the best performing boats in the industry. Boats that allow you to escape the routine of every day life. You see... you don't just own a Nautique, you live the Nautique life.

Your boat has been built with the best material and workmanship available, a legacy handed down from our founder. Our wealth of experience gives us the edge in innovation, quality, and performance. We have the most dedicated and loyal employees in the industry. Hands down. Every day, our employees do more than just punch a clock; they take personal pride in every boat that comes down the line.

Review this Owner's Manual for your boat. We have assembled this manual to inform you about your boat and educate you further on boating. Please pay particular attention to the safety statements labeled as **DANGER, WARNING, CAUTION** and **NOTICE**. These statements alert you to possible safety hazards to avoid so you can have a safer boating experience. There are also many tips and tricks on care and maintenance sprinkled throughout the manual. Boating is very important to us and we would like you to enjoy many years of boating in your Nautique.

By purchasing a Nautique, you have taken the first step in trading your old lifestyle for a new one. Now that you own a Nautique, life as you know it will never be the same.

Live It!

The Correct Craft Family

Keep your heart with all diligence,
for out of it spring the issues of life.

Proverbs 4:23





Record Important Information

In addition to this manual, your Correct Craft boat is supplied with component manufacturer information such as instructions, warranties or other important information. Read these materials carefully since improper operation and maintenance can void the warranty and jeopardize personal safety.

Safeguard information about your Correct Craft boat by recording the Hull Identification Number (HIN) and the model of your boat, and the model and serial numbers of your engine/transmission and trailer, if applicable.

Your HIN is located on the top right side of the transom, above the water line. The U.S. Coast Guard requires that your HIN be permanently affixed and remain on the top right side of the transom. The first three digits represent Correct Craft, Inc. (CTC) The next five digits are the boat's serial number. The next digit is a letter from "A" where "A" = January through "L" where "L" = December, designating the month the boat was made.

The last three digits represent the last digit of the year the boat was built and the final two digits of the boat model year. A boat built in July 2003 is actually a 2004 model boat. Example: A boat with "304" as the last digits indicates the boat was built in 2003, but it is a 2004 model boat.

Hull

HIN _____
 Date Purchased _____
 Dealer/Phone _____
 Ignition Key Number _____
 Registration Number/State _____

Engine

Model Number _____
 Serial Number _____

Trailer

Model Number _____
 Serial Number _____

Accessory

Model Number _____
 Serial Number _____

The identification numbers are important! Keep a copy of these numbers stored in a safe place off the boat. In case of theft, damage, etc., report these numbers to the local authorities, your insurance agent and your Correct Craft dealer.



Boater's Checklist

For improved safety and enjoyment, check each of these items:

Check Before You Launch Your Boat:

- Read both the engine and the boat operator manuals.
- Drain plug (Securely in place?)
- Propeller Condition (prop nut tight and secured, no cracked or bent blades, prop turns freely)
- Steering System (Working smoothly and properly, self locking nuts in place)
- Battery (fully charged, cable terminals clean and tight)
- Capacity Plate (Are you overloaded?)
- Weather conditions (Safe to go out?)
- Fuel and Oil (Sufficient for trip, check bilge area for gas odor, no leaks)
- Hoses and Connectors (no leaks or damage)
- Electrical Equipment (Lights, horn, pumps, etc.)
- Safety Equipment (Fire extinguisher, bailer, paddle, anchor and line, mooring lines, signaling device, tool kit, first aid kit, first aid manual)
- Float Plan submitted to Responsible Person (Verbal or written)

Check Before You Start Your Engine:

- Fuel (Sufficient for trip, check bilge area for gas odor)
- Control Lever in Neutral
- Capacity Plate (Are you overloaded?)
- Personal Flotation Devices for all occupants
- Seating (Everyone in proper place?)
- Engine Stop Switch and Lanyard (Operational and securely fastened?)
- No one in water near boat
- Keep firm and continuous grip on steering wheel
- Engine Cooling Water Valve open





Restricted Areas

Before boating, check with Local, State and Federal authorities to identify restricted areas. Because of the threat of terrorism, the U.S. Coast Guard has and will continue to implement strict limits on watercraft near U.S. Navy and Coast Guard ships and other potential targets.

Emission Control Warranty Information



CORC013

The engine in your Correct Craft boat meets the strict requirements set forth by the California Air Resources Board (CARB). The engine has a special environmental tag and the boat has this label affixed to it. The tag and the label are required by the California Air Resources Board (CARB). The label has 1, 2, 3 or 4 stars. The label **MUST** be affixed to the boat, if the boat is operated in the state of California and/or bordering waters.

Boating Terminology

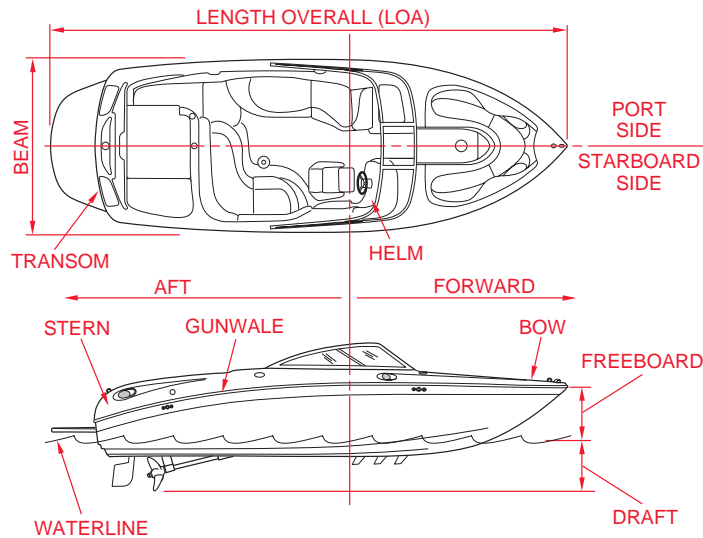

CORC001

* An easy way to remember PORT side from STARBOARD side is "PORT" and "LEFT" both have four letters.



Table of Contents

Welcome	i	Emergency Stop Switch and Lanyard.....	1-21
Record Important Information.....	ii	Emergencies.....	1-22
Boater's Checklist.....	iii	Fire/Explosion	1-22
Restricted Areas	iv	Capsizing and Swamping.....	1-23
Emission Control Warranty Information	iv	Collisions.....	1-23
Boating Terminology.....	iv	Grounding	1-23
Boating Safety	1-1	Water Rescue (Man Overboard).....	1-23
Safety While Boating	1-1	Medical Emergency.....	1-24
General Precautions.....	1-3	Operation Failure.....	1-24
Boat Safety Labels.....	1-5	Hazardous Conditions	1-24
Boating Regulations	1-8	Shallow Water Operation.....	1-24
Boater Responsibilities.....	1-8	Weeds	1-24
Registration/Documentation.....	1-9	Dam Spillways	1-25
Insurance.....	1-10	Weather/Seas.....	1-25
Education Opportunities.....	1-10	Warning Markers.....	1-26
Operating By Minors.....	1-11	Carbon Monoxide	1-27
Overloading	1-11	Our Environment.....	1-28
Passenger Safety and Seating.....	1-13	Foreign Species	1-28
Visibility	1-13	Fuel/Oil Spillage.....	1-28
Boating Under the Influence	1-14	Discharge/Disposal of Waste.....	1-29
Reporting Accidents.....	1-14	Excessive Noise	1-29
Rendering Assistance	1-15	Wake/Wash.....	1-29
Required Safety Equipment	1-15	Exhaust Emissions.....	1-29
Life Saving Equipment	1-16	Paints	1-29
Navigation Lights	1-17	Cleaning Agents	1-30
Horn or Whistle	1-18	MARPOL Treaty	1-30
Fire Extinguisher.....	1-18	Water Sport Safety	1-30
Visual Distress Signals	1-18	Teak/Drag Surfing.....	1-30
Recommended Safety Equipment	1-20	General Water Sport Precautions	1-32
		Watersports Responsibility Code	1-35

Nautique





Basic Rules of the Road	2-1	Control Switches.....	4-7
Aids to Navigation	2-1	12 Volt Port	4-9
USWMS System	2-2	Ignition Keyswitch	4-9
Uniform State Regulatory		Fuse Panel	4-10
Markers.....	2-3	Dash Pod – LE or Team.....	4-11
FWMS System	2-3	Optional Ignition and	
Right-of-Way	2-5	Switch Panel.....	4-11
Privileged Boats	2-5	Gauges.....	4-16
Burdened Boats	2-5	Tachometer/Fuel	
Crossing Situation	2-6	Monitor	4-24
Meeting Head-On	2-7	Warnings	4-29
Overtaking	2-8	Switches	4-30
The General Prudential		Standard Equipment.....	4-33
Rule.....	2-9	Tow Pylon.....	4-33
Night Running.....	2-9	Bow Features of Your 206	
196 and 206 Ski.....	3-1	Ski Nautique	4-34
Specifications	3-1	Driver’s Seat	
196 Ski.....	3-1	Adjustment.....	4-34
206 Ski.....	3-1	Rearview Mirror	
Standard Dash Pod		Adjustment.....	4-35
and Console	3-3	Love Seat.....	4-36
Optional Dash Pod		Storage Hatch/Floor	
and Console	3-4	Cooler - 206 only	4-36
Optional Ignition and		Engine Box Cover Latching/	
Switch Panel	3-5	Lifting/Removal.....	4-37
196 Ski Deck Layout.....	3-6	Aft Seat Bottom	
206 Ski Deck Layout.....	3-8	Cushion	4-38
Standard and Optional		Walk Thru Windshield	
Equipment	3-10	Opening/Latching	
Controls and Indicators	4-1	(optional on 196 Ski)	4-38
Controls and Indicators	4-1	Dash and Floor Coolers...	4-38
Steering	4-1	Boarding Platform	4-39
Shifter/Throttle.....	4-3	Engine Cooling Water	
Emergency Stop Switch	4-4	Intake Valve.....	4-40
SE Dash Pod.....	4-5	Fuel Tank	4-40
Gauges.....	4-5	Optional Equipment.....	4-41
Speedometer Calibration	4-7	Stereo and Speaker	
		Pods	4-41
		Automatic Bilge Panel	4-41



Battery Safety Switch	4-41	Anchoring	7-4
Board Racks	4-42	Dropping Anchor	7-5
Folding Instructions for Optional Flight Control Tower	4-43	Weighing (Pulling In) Anchor	7-5
Rear Ballast Tank	4-44	Performance Boating	7-6
Ballast Tank/Valve(s)	4-44	Propellers	7-6
Optional Rudder Remote Lube - 206 Ski	4-45	Care and Maintenance	8-1
Optional Accessories	4-45	General Maintenance	8-1
Correct Craft Cruise – Operating Instructions	4-45	Engine Intake Water Strainer	8-2
Boat Systems	5-1	Bilge Pumps	8-4
Fuel System	5-1	Propeller	8-4
Optional Heater and Shower System	5-3	Removal	8-4
Ballast Tanks and Bilge System	5-4	Installation	8-5
Getting Underway	6-1	Propeller Shaft Stuffing Box	8-6
Safety Checklist	6-1	Non V-Drive Models	8-6
Safety Equipment	6-2	Through-Hull Fittings	8-8
Fueling	6-2	Quick Oil Drain System	8-9
Boarding	6-3	Salt Water Boating	8-9
Boat Planing	6-4	Battery Maintenance	8-10
Pre-Operation Checks	6-4	Gelcoat Maintenance	8-11
Flooded Engine	6-9	Teak Care	8-12
Break In Procedure	6-11	Care of Metal	8-13
Propeller Selection	6-11	Care of Glass	8-13
Shifting	6-12	Vinyl Maintenance and Cleaning	8-13
Steering	6-12	Tunable Rudder	8-15
Stopping	6-13	Rudder Remote Lube Fitting (if equipped)	8-17
Docking	6-13	Troubleshooting	9-1
Running	7-1	Trouble Check Chart	9-2
Maneuvering Techniques	7-2	Performance	9-2
Tow Pattern	7-3	Electrical	9-3
Freezing Temperatures	7-4		





Storage	10-1	Glossary	G-1
Lifting Rings.....	10-1	Warranty	W-1
Winterizing Your Boat.....	10-2	CORRECT CRAFT LIMITED	
Check for Water in Your Fuel		WARRANTY	W-1
System	10-4	Lifetime Limited	
Winterizing Optional Rear		Warranty.....	W-1
Ballast Tanks.....	10-5	Transferable Lifetime	
Trailer/Trailering	10-6	Limited Warranty	W-1
Hitch.....	10-6	Five (5) Year Limited	
Wiring.....	10-6	Warranty, Transferable	W-2
Security.....	10-6	ENGINE Three (3) Year	
Towing Your Boat.....	10-7	Transferable Limited	
Long Trips.....	10-8	Warranty.....	W-2
		Request for Warranty	
		Transfer	W-5
		Nautique Service Centers....	W-8



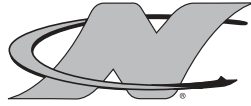

Section I Boating Safety

Safety While Boating

Boating-related accidents are generally caused by the operator's failure to follow basic safety rules or written precautions. Most accidents can be avoided if the operator is completely familiar with the boat, its operation and can recognize potentially hazardous situations.

In addition to everyday safety, failure to observe the safety recommendations may result in severe personal injury or death to you or to others. Use caution and common sense when operating your boat. Don't take unnecessary chances! Remember that at least three people are needed for safe towing.

Failure to adhere to these warnings may result in severe injury or death to you and/ or others.

- **Look before you turn the boat. As a boater you are obligated to maintain a course and speed unless it is safe to alter course and speed. Look before you turn.**
- **Improper operation of the boat is extremely dangerous. Operators must read and understand all operating manuals supplied with the boat before operation.**
- **On-board equipment must always conform to the governing federal, state and local regulations.**
- **Prior to starting the engine, you must open the engine box and check the engine compartment and bilge for gasoline and oil vapors. You must also operate the blower for at least four minutes. Failure to do so may result in fire or explosion. If you smell gasoline vapor or see liquid gasoline, DO NOT start the engine.**

Section I

NEUTRAL

- **DO NOT** operate the boat while under the influence of alcohol or other drugs.
- **DO NOT** stand or allow passengers to stand in the boat, or sit on the transom, seat backs, engine cover or sides of the boat while the engine is running. You or others may be thrown from the boat.
- **DO NOT** allow any type of spark or open flame on board. It may result in fire or explosion.
- **DO NOT** leave children in the boat without adult supervision.
- **DO NOT** sit in front of the operator to avoid obstructing the operator's view.
- **DO NOT** dive from the boat without being absolutely sure of the depth of the water, otherwise severe injury or death may occur from striking the bottom or submerged objects.
- **DO NOT** swim near the boat when the engine is running. Being in NEUTRAL is not enough, the propeller may still be turning and carbon monoxide may be present.
- **DO NOT** replace your boat's marine parts with automotive parts.
- **DO NOT** remove or modify any components of the fuel system except for maintenance by qualified personnel. Tampering with fuel components may cause a hazardous condition.
- **DO NOT** wrap ski lines or mooring lines around any body part which may become entangled in the line if you fall overboard and the boat is moving.
- Keep track of ski lines and dock lines so they do not become entangled in the propeller.
- Be sure to securely attach the engine Emergency Stop switch lanyard to a part of your clothing, such as a belt loop, when operating the boat.
- Be sure to keep a watch for other boats, swimmers and obstructions in the water. Stay away from other boats and personal watercraft.
- Be sure to have an experienced operator at the helm and always have at least three people present for safe towing – one to drive, one to observe and one to ski or ride.



Boating Safety

- Seek shelter from open water if there is threat of lightning.
- Operate slowly in congested areas such as marinas and mooring areas.
- The bow may be slippery, do not go forward while the engine is running.
- When you leave the boat take the keys with you. This will keep untrained and unauthorized persons from operating the boat.
- Engine exhaust contains carbon monoxide.
- DO NOT operate the engine in a confined space.
- DO NOT go under the boat cover with the engine running or shortly after the engine has been running.
- DO NOT use boarding platform with the engine running.
- DO NOT “teak surf.”
- Allow adequate ventilation with fresh air before entering.
- Slow down when crossing waves or wake in order to minimize the impact on passengers and the boat.

General Precautions

Your safety, the safety of your passengers, and other boaters are among your responsibilities as operator of this boat. Your boat must be in compliance with USCG safety equipment regulations. You should know how to react correctly to adverse weather conditions, have good navigation skills, and follow the "Rules of the Road" as defined by the USCG and state/county/local regulations.

Before each outing you should check all safety equipment, such as fire extinguishers, PFDs, flares, distress flags, flashlights and emergency stop switch. They should be operable, in good condition, readily visible and easily accessed.

Know the weight capacity of your boat. DO NOT overload your boat.

This section covers general boating safety information. Throughout this manual specific precautions and symbols identify safety related information.



Section I



The Safety Alert Symbol means ATTENTION! BECOME ALERT! YOUR SAFETY IS INVOLVED!



Indicates an imminently hazardous situation that, if not avoided, will result in death or serious injury.



Indicates a potentially hazardous situation that, if not avoided, could result in death or serious injury.



Indicates a potentially hazardous situation that, if not avoided, could result in minor or moderate injury or property damage. It may also be used to alert against unsafe practices.

NOTICE

Indicates installation, operation or maintenance information which is important but not hazard-related.

The precautions listed in this manual and on your Correct Craft boat are not all-inclusive. If a procedure, method, tool, or part is not specifically recommended, you must satisfy yourself that it is safe for you and others, and that the boat will not be damaged or made unsafe as a result of your decision. **REMEMBER - USE COMMON SENSE WHEN OPERATING YOUR BOAT!**



Boating Safety

Boat Safety Labels

Your Correct Craft boat is affixed with various safety labels at the time of manufacture. These labels appear at specific locations on the boat where safety is of particular concern. Safety labels must be legible. If you suspect a label is missing or one becomes damaged, contact your Correct Craft Dealer for immediate replacement.



CORC007

Tow Pylon



CORC004

Engine Inside Box and on Fuel Tank



CORC091

Water Strainer

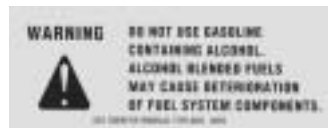

CORC005

Fuel Fill

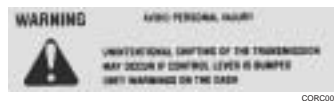

CORC006

Throttle Control



CORC008

Transom Warning



CORC010

Cross Member/Boarding Platform



CORC092

Engine

Nautique



Section I

NAUTIQUE

WARNING! DO NOT
ATTEMPT TO START OR OPERATE
ENGINE WITH FLAME ARRESTOR REMOVED

CORC093

Flame Arrestor

WARNING!
Avoid personal injury
or property damage
caused by flying objects.
Remove any items from
board racks when
trailing boat.

CORC094

Board Racks

CAUTION: TO AVOID INJURY, WINDOW MUST BE SECURED
IN THE CLOSED POSITION WHEN VESSEL IS
IN MOTION. USE BOTH WINDOW LOCKS.

CORC064

Walk Through Windshield

▲ DANGER
A spinning propeller or carbon monoxide
fumes can cause serious injury or death.
Do not start or run engine while anyone is
on or near the boarding platform. Do not
operate this boat without a Correct Craft
Inc. boarding platform secured in place.

▲ WARNING
Gasoline vapors can explode resulting
in injury or death. Before engine start
up, check engine compartment for
gasoline vapors, then run blower for
four minutes, then run blower for
four minutes, then run blower when
before cruising speed.

CORC009

Dash Pod

CAUTION! Avoid equipment
damage. Do not operate boat if
light stays on above 1200 RPM.

CORC012



Boating Safety



Fuel Control Cell



Side Console

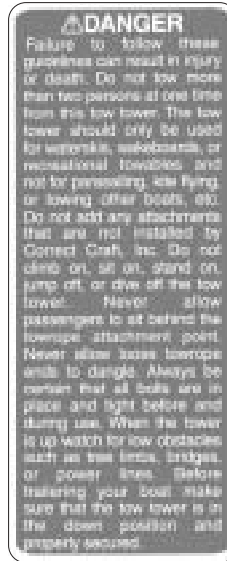

Flight Control Tower

NAUTIQUE



Section I

REGISTRATION

Boating Regulations

The U.S. Coast Guard (USCG) is the authority of the waterways; they are there to help the boating public. State boating regulations are enforced by local authorities. You are subject to marine traffic laws and "Rules of the Road" for both federal and state waterways; you must stop if signaled to do so by enforcement officers, and permit to be boarded if asked.

There are many pamphlets, prepared by the USCG, available to you. These pamphlets explain "Rules of the Road," signal lights, buoys, safety, international and inland regulations and much more than is presented in the manual. For more information contact your local USCG Unit or call the Coast Guard Customer Infoline at 1-800-368-5647.

Boater Responsibilities

It is the owner's responsibility to ensure that the operator of the boat has been properly instructed in the lawful and safe operation of this vessel. Therefore, before operating the boat, read this owner/operator manual. Be sure you understand each item before operating it. Improper operation or trailering of the boat could lead to severe damage and/or injury.

At the time of delivery, the owner/operator is responsible for:

- Understanding warranty terms and conditions of your boat, your engine and your trailer.
- Obtaining insurance.
- Examining boat to ensure proper operation of all systems.

Before operating the boat, the owner/operator is responsible for:

- Obtaining state registration of the boat.
- Providing the proper USCG required safety equipment.
- Following proper break-in procedure for the engine.
- Understanding safety information and proper operating procedures within this manual.



Boating Safety

While operating the boat, the owner/operator is responsible for:

- Knowing that all safety equipment and personal flotation devices (PFDs) are in good condition and suitable for your boat and passenger load.
- Knowing that the capacity of the load are within the limits stated on the USCG Maximum Capacities Plate.
- Verifying that the emergency stop switch is in proper operating condition.
- Ensuring that all passengers are properly and securely seated in appropriate seating locations.
- Following safe operating practices and the “Rules of the Road.”
- Understanding proper maintenance and knowledge of the boat’s operating systems.
- Providing safety training for the passengers.
- Having at least one other passenger who is capable of handling the boat in an emergency.
- Maintaining a proper lookout by sight and hearing.
- Avoiding use of alcohol and other drugs.
- Providing assistance to other boaters.

Registration/Documentation

The USCG requires that all power boats operated on the navigable waters of the U.S. must be registered in the state of main use; also, many states require registration in that state whenever boating on waters within their state boundary. Contact your state boating authorities (and neighboring states) for registration information on boats and trailers. Your Correct Craft Dealer can supply you with the appropriate forms.

2003
N
A
U
T
I
Q
U
E
S
K
I
S
E
C
1



Section I



Insurance

You must get insurance before operating your new boat. Insurance for loss by fire, theft or other causes, or liability protection against accidents is a must for responsible boaters. The boat owner is legally responsible for any damage or injury caused when he, or someone else operating the boat, is involved in an accident. Many states have laws detailing minimum insurance needs. Your insurance agent or your Correct Craft Dealer may be able to supply you with more information.

Education Opportunities

This manual is not intended to provide complete training on all aspects of boat operation. We strongly recommend that all operators of this boat seek additional training on boat handling and safety. Have all operators become familiar with the handling characteristics, and proper steering and control system usage before attempting high speed operation.

Some states require youths 16 years of age and younger to complete a boating safety course before operating any watercraft. Many others require operators under the age of 18 to be licensed in small boat operation.

Boat smart from the start, take a boating safety course and get a free vessel safety check annually for your boat. For more information, contact: United States Coast Guard Auxiliary, 1-800-368-5647, www.cgaux.org; United States Power Squadrons, 1-888-FOR-USPS, www.usps.org.

Most boaters can enhance their enjoyment of boating experiences through increased knowledge of safe operation, navigation and regulation of pleasure boats. The following is a list of some other agencies and organizations that offer Water Safety, First Aid and CPR courses or information. To find boating safety courses in your area, call your state's local boating agency or the USCG boating safety course line at 1-800-336-2628 (1-800-245-2628 in Virginia).



Boating Safety

- American Red Cross
- U.S. Coast Guard Auxiliary
- U.S. Power Squadrons
- State Boating Offices
- Canadian Power and Sail Squadrons
- Boat Owners Association of the United States
- National Safe Boating Council

Operating By Minors

Minors must be supervised by an adult whenever operating a boat. Many states have laws regarding the minimum age and licensing requirements of minors. Be sure to contact the state boating authorities for information.

Overloading

DO NOT overload your boat. Your boat is equipped with a required capacity plate indicating the maximum acceptable load as determined by the manufacturer following certain Federal guidelines. If in doubt, contact your Correct Craft Dealer.



CORC021

The capacity plate is used by boat manufacturers participating in the National Marine Manufacturers Association certification program. Correct Craft has submitted your model for inspection and compliance with their guidelines.

The capacity plate has the following information permanently printed on it. It is attached to the boat by the throttle for the operator to read before they drive the boat.



NATIONAL MARINE MANUFACTURERS ASSOCIATION

Section I

NAUTIQUE

- The total weight of persons, gear and other items which the boat is capable of carrying under normal conditions. **This weight must include any water added to ballast other than the Correct Craft Launch Control System.**
- The maximum number of persons allowed on the boat. This information on the capacity plate applies under normal conditions and special care must be used in any other than normal conditions. Check the capacity plate on your boat and abide by these limits.

NOTICE

Correct Craft, Inc. installs a permanent wake enhancement ballast tank system in some models. The full weight of this system has already been considered in the boat weight and therefore does not influence maximum capacity, unlike portable ballast tanks or weights, which must be included as part of the gear weight.

CAUTION

A fully loaded Nautique will handle differently than a lightly loaded one. Drive and turn your Nautique with this in mind. As wakeboarding has developed, we have witnessed the advent of ballast systems which add weight and increase the size of the wake. The simplest ballast system on the market is the water ballast type, such as the "phat sack." It is not uncommon to see operators use such systems and then put additional people in their boat. Please be advised that this practice can lead to overloading your boat. Each Correct Craft, Inc. boat has a required capacity label that meets the maximum weight of people, gear, and ballast that can be placed in the boat. Always be aware of the load in your boat and do not load the boat in excess of the listed capacity. The quest for the "phattest" wake has caused some to excessively overload their boats. This may adversely affect the operation of the boat, possibly resulting in injury to persons inside and/or outside of the boat. Avoid personal injury. DO NOT overload your Nautique.



Boating Safety

Passenger Safety and Seating

Make sure that at least one passenger is familiar with the operation and safety aspects of the boat in case of an emergency. Show all passengers the location of emergency equipment and explain how to use it.

The operator of the boat is responsible for the safety of the passengers as well as his/her own safety. The operator should ensure that all passengers are properly and securely seated in appropriate seating locations before starting.

While the engine is running, and during the boat mooring, all occupants should be properly seated. DO NOT sit on the engine box, seat backs, boarding platform or gunnels. You could fall overboard and be hit by the propeller. DO NOT allow objects, arms or legs, or any other body parts to hang over the bow or gunnels.

DO NOT stand while the boat is moving.

The operator must sit in the driver's seat while the boat is moving and all passengers remain properly seated.

Visibility



WARNING

Clear visibility must be maintained at all times. If necessary, arrange passengers and equipment for maximum visibility. Designate a passenger to assist when visibility is limited due to operating conditions.

The operator of the boat is responsible by law to "maintain a proper lookout by sight and hearing." The operator must ensure that he/she has an unobstructed view particularly to the front. No passengers or equipment should block the operator's view.

Look carefully before turning, especially when you are turning around to pick up a fallen skier. Someone else may not be following the "Rules of the Road."



Section I

Keep a visual check for boats behind your boat. This is an area where accidents can happen very quickly.

The boat should not be driven at a rate of speed faster than will allow it to be brought to a full stop within the operator's field of view.

Boating Under the Influence

WARNING

Federal and state law prohibit operating a boat under the influence of alcohol and other drugs. These regulations are actively enforced. Impaired operation may result in severe personal injury or death.

Boating, alcohol and the use of other drugs just don't mix. Mixing boating, alcohol and other drugs result in many marine accidents and deaths. These substances reduce your reaction time and impair your judgment. Combined with the sun, wind, waves, and noise of other watercraft, the effects of drugs are increased and will significantly reduce your reaction time. As the owner/operator, you are responsible for the alcohol/drug use and onboard behavior of your passengers.

NOTICE

If the operator's blood alcohol content is 0.10% (0.08% in some states) or above, violators are subject to a civil penalty up to \$1,000.00 or criminal penalty up to \$5,000.00, one year imprisonment or both. Operating a boat under the influence can also result in a loss of automobile driving privileges.

Reporting Accidents

The USCG requires the owner or operator of a boat involved in an accident, to report the incident to the proper marine law enforcement agency for the state in which the accident occurred. Immediate notification to the nearest State boating authority is required if a person dies or disappears as a result of a recreational



Boating Safety

boating accident. If a person dies or sustains injuries requiring more than first aid, a formal report must be filed within 48 hours of the accident. A formal report must be filed within 10 days for accidents exceeding \$500 in property damage or complete loss of boat.

Rendering Assistance

If you see a distress signal or suspect a boat is in trouble, you must assume it is a real emergency and render assistance immediately. By law, the operator in charge of the craft is obligated to provide assistance to any individual in danger if such assistance can be provided safely. Failure to render assistance can result in a fine and/or imprisonment.

The 1971 Boating Safety Act grants protection to a "Good Samaritan" boater providing good faith assistance, and absolves a boater from any civil liability arising from such assistance.

Required Safety Equipment

The Federal Boat Safety Act of 1971 (FBSA/71) established minimum safety standards for boats and associated equipment, specified by the USCG. In addition, the ABYC and the NMMA work with boat builders to develop voluntary standards that exceed base requirements.

The included safety equipment on your Correct Craft boat meets or exceeds the standards of the USCG, ABYC and the NMMA. Some required safety equipment such as PFDs are not included with your Correct Craft boat. Your Correct Craft Dealer can help you choose the appropriate equipment.

NOTICE

*Many states' equipment requirements go beyond USCG requirements.
Contact your state boating office for further information.*

Equipment requirements for coastal and inland waters differ. Check with local authorities or the USCG for further information about coastal water requirements.

The following equipment may or may not be required by federal/local regulations.

Ski



I-15

2
3
4
5
6
7
8
9
10
11
12
13
14
15

Section I

Nautique

Life Saving Equipment

Federal law requires at least one Type I, II, III, or V Personal Flotation Device (PFD), of the proper size, for each person on board or being towed, and at least one Type IV throwable PFD in the boat.

There are four types of PFDs to wear and one type used for throwing in emergency situations.

Type I Life Preserver: Most buoyant PFDs are effective on all waters, especially open, rough water.

Type II Buoyant Vest: Good for calm water near shore on most inland waters where quick rescue is likely.

Type III Flotation Aid: Good for most inland water applications where quick rescue is likely. Comes in various styles and some are designed for water sport activities.

Type V Hybrid PFD: Inflatable design for special use activities and may be used instead of a Type I, II, or III PFD if used in accordance with the approval conditions on the label and if worn when the boat is underway. Some Type V PFDs provide increased protection against hypothermia.

NOTICE

- *A Type V PFD must be worn to be counted toward the minimum carriage requirements.*
- *Special PFDs are available for skiing and other water sports. These PFDs are constructed with materials suitable for high impact falls.*

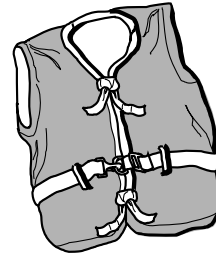

**Type I
Life Preservers**



**Type II
Buoyant Vests**



**Type III
Flotation Aids**

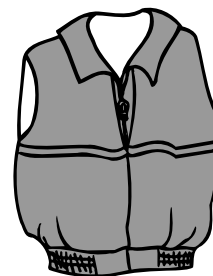

**Type V - Hybrid PFD
Must Be Worn
When Underway**



Boating Safety

PFDs are intended to help save lives. The operator should set an example by wearing one. Wear a PFD whenever boating. It is especially important that children and non-swimmers wear a PFD at all times. Make certain all passengers know how to put on and properly adjust their PFDs. Also, selecting the proper type PFD for your kind of outing helps ensure your time on the water can be the safest possible.

At the beginning of each season, check PFDs for damage and test for proper flotation. Refer to the PFD manufacturer's information.

All boats over 16 feet (4.8 meters) in length must carry one USCG approved Type IV throwable lifesaving device, such as a ring buoy or buoyant cushion. To meet requirements, each lifesaving device must have a current, legible USCG approval stamp permanently affixed.

Type IV Throwable Device: Intended for heavy traffic inland waters where help is available. Designed to be thrown to a person in the water and should never be worn.

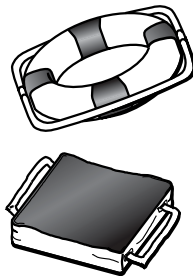

**Type IV
Throwable Devices**

Your Correct Craft Dealer can help you select appropriate PFDs and throwable lifesaving devices for your area.

Navigation Lights

All power boats underway between sunset and sunrise must display proper navigation lights. All boats at anchor must display a proper anchor light. The anchor light must be visible 360 degrees.



Section I

Nautique

Horn or Whistle

All boats over 16 feet (4.8 meters) in length must be equipped with an operable horn or whistle, audible from one mile. Your Correct Craft boat is equipped with a USCG approved horn.

Fire Extinguisher

At least one approved B-1 portable fire extinguisher is required. Make sure all passengers know the location and operating procedure for each fire extinguisher. Check fire extinguisher regularly for condition and state of charge.

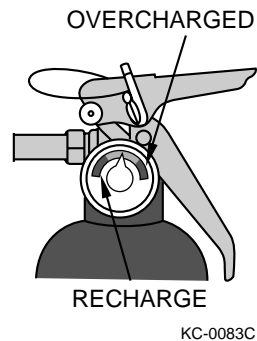

1. Overcharge
2. Recharge

Portable Fire Extinguisher

Visual Distress Signals

All boats over 16 feet (4.8 meters) must have onboard day and night visual distress signals when operating on coastal waters, the Great Lakes, territorial seas or those waters directly connected to them, up to a point where the body of water is less than two miles wide. Carry several types of signaling devices to handle a variety of conditions. Your Correct Craft Dealer can help you select appropriate visual distress signals for your area.







If you are required to carry distress signals, you must have three USCG approved pyrotechnic devices. Be sure they are in serviceable condition, not exceeding the expiration date and stored in a cool, dry location in a waterproof container. Have enough signals on board to last three days.

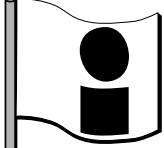

Boating Safety

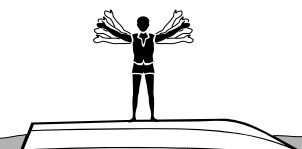
⚠ WARNING Pyrotechnic signaling devices can cause injury and property damage if improperly handled. Follow the manufacturer's directions.

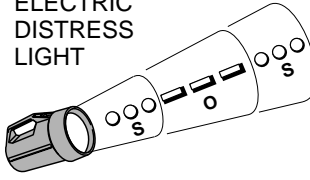
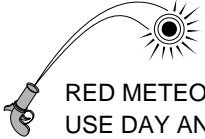
VISUAL DISTRESS SIGNALS

 <p>ORANGE FLAG</p> <p>USE DAY ONLY</p>	 <p>RED DISTRESS FLARE (HAND)</p> <p>USE DAY AND NIGHT</p>
 <p>ARMS SIGNALS (USE BRIGHT CLOTH)</p> <p>USE DAY ONLY</p>	 <p>ORANGE SMOKE SIGNAL (HAND)</p> <p>USE DAY ONLY</p>
 <p>ELECTRIC DISTRESS LIGHT</p> <p>USE NIGHT ONLY</p>	 <p>RED METEOR FLARE</p> <p>USE DAY AND NIGHT</p>
	 <p>DYE MARKER</p> <p>USE DAY ONLY</p>

KC-0082



Section I

Nautique

Recommended Safety Equipment

As a precaution, a good boater will avoid potential problems on an outing by having additional equipment on board. Normally, this equipment is dependent on the body of water and the length of the trip; your Correct Craft Dealer can assist you:

- First aid kit and manual
- Anchor with at least 75 feet (23 meters) of line
- Mooring lines and fenders
- Bailing device (bucket, hand pump)
- Combination oar/boat hook
- Local charts and compass
- Day/night distress signals
- Waterproof flashlight and spare batteries
- Cellular phone
- Binoculars
- Portable AM/FM radio with weather band
- Lubricant
- Tool kit
- Spare propeller and mounting hardware
- Spare fuses
- Spare keys
- Sunglasses and sun block lotion

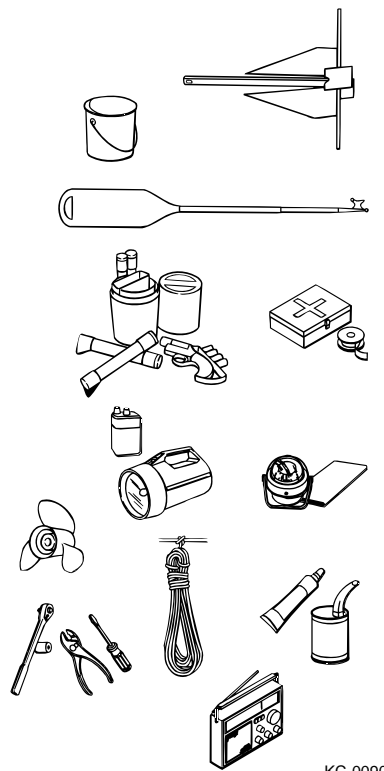

KC-0090



Boating Safety

Emergency Stop Switch and Lanyard

Your Correct Craft boat is equipped with an emergency stop switch and lanyard. Correct Craft strongly recommends that the lanyard be secured to the operator and the lock plate attached to the emergency stop switch prior to starting the engine and anytime the engine is operating.

The lanyard is designed to turn off the engine whenever the operator moves far enough away from the helm to activate the switch. It is strongly recommended that the lanyard be used by the operator.

WARNING

- **DO NOT** operate the boat if the Emergency Stop Switch system does not function properly.
- **Attach the emergency stop switch lanyard to a secure place on your clothing, your arm or leg while operating.**
- **DO NOT** attach the lanyard to clothing that could tear loose. **DO NOT** route the lanyard where it could become entangled, preventing it from functioning.
- **Avoid accidentally pulling the lanyard during normal operation. Loss of engine power means loss of most steering control. Also, without engine power, the boat could slow rapidly. This could cause people and objects in the boat to be thrown forward.**

There are practical limitations to what the emergency stop switch and lanyard can do. It can take several seconds for the engine and propeller to stop turning. The boat can continue to coast for several hundred feet depending on the velocity at the time the switch was activated, and the degree of any turn. While the boat is coasting, it can cause injury to anyone in its path as seriously as if the boat operated under power.



Section I



Replacement lanyards should be of sufficient length to avoid inadvertent activation. Accidental loss of power can be hazardous particularly when docking or in heavy seas, strong current or high winds.

Emergencies

Be prepared to deal with emergencies before they happen. Try to formulate a plan for each type in advance so that decisions can be made quickly and without hesitation. Precious moments lost can mean the difference between losing and saving a life.

Fire/Explosion

You must be prepared and act quickly when dealing with a fire. It is not recommended to battle a fire for an extended period of time. Turn engines off and abandon the boat if the fire cannot be extinguished quickly. Swim at least 25 yards (23 meters) upwind from the boat and use the visual distress signals to get assistance.

WARNING

Gasoline will float on top of water and can burn. If the boat is abandoned, swim upwind, far enough to avoid fuel that may spread over the surface of the water.

Onboard fires involving the fuel system usually result in either an explosion that completely destroys the boat, or the boat burning to the waterline and self-extinguishing. Deciding on abandoning the boat or staying to fight the fire is difficult and depends on many factors. Try to formulate a fire plan in advance to make that decision quickly and without hesitation.

Be sure to:

- Use caution and do not smoke when refueling.
- Verify that fuel does not leak.
- Use only marine approved equipment on your boat.



Boating Safety

Capsizing and Swamping

A boat may capsize or swamp when least expected. Like fires, try to formulate a plan in advance on what to do if it should happen. Keep in mind the following guidelines:

- Try to turn the engine OFF to prevent damage.
- If others were on board, try to locate them, make sure they're conscious and that they can swim.
- **Stay with the boat, it will float!** Climb up on the hull and try to get assistance.
- Don't try to swim to shore. It's usually farther than it looks.

If a leak is discovered, immediately determine the cause. A collision with an underwater object could cause the hull to develop a leak. A loose fitting or hose clamp on a piece of equipment could cause a leak. Try to repair the leak if possible. If a leak is threatening the safety of you and your passengers, call or signal for assistance.

Collisions

If a collision occurs, immediately account for all passengers. Assess the hull for damage and activate the bilge pumps to reduce any water intake. Try to operate the boat to keep the damaged area above water. If necessary, call or signal for assistance.

Grounding

In the event you run aground, assess the situation before proceeding. Immediately stop any water from entering the boat. Inspect the rudder and rudder control system, the hull, propeller and strut for damage. Maneuver the boat to safe water only if the hull and all operating systems are in satisfactory operating condition. Otherwise, call or signal for assistance.

Water Rescue (Man Overboard)

Immediately react to a person who has fallen overboard. Keep the victim constantly in your sight. Safely return to the victim as soon as possible. Throw the person a life preserver. Turn off the engine and help the person into the boat.



Section I

OPERATION

Medical Emergency

Be prepared in the event of an emergency. Know how to use your first aid kit. Be aware of any special medical conditions of your passengers.

Operation Failure

If you experience a propulsion, steering or control failure, immediately turn OFF the engine. Try to determine the failure and repair, if possible. Otherwise, call or signal for assistance.

Hazardous Conditions

Every waterway poses hazards that you should avoid, such as shallow water, tree stumps and sand bars. Ask local boaters for information and consult a marine chart when boating on unfamiliar waters. As the operator of the boat, you should try to avoid all hazards, known and unknown. The following information does not contain all possible water hazards.

Shallow Water Operation

Operating in shallow water presents a number of hazards. If a vibration is noticed after striking an object, it may indicate a damaged propeller shaft or propeller.

Sand bars in narrow inlets are constantly shifting, making it difficult to mark them with buoys. Tides in coastal areas affect water levels producing sand bars. Sometimes sand bars are indicated by waves as they form into breakers when passing over the sand bar. Refer to Grounding, in this section, if you run aground on a sand bar.

Weeds

Weeds are generally a threat to your boat's engine. Weeds on the propeller may cause a vibration. They may also restrict water intake causing the engine to overheat. If you run into weeds, stop the engine and clear the propeller and water intakes completely of weeds. Refer to your engine Operator's Manual for additional information.



Boating Safety

Notice

Weeds can sometimes be removed by shifting to NEUTRAL, pausing for a moment, then shifting to REVERSE to unwind the weeds from the propeller.

Dam Spillways

The water level around a dam spillway is a hazardous area. It is subject to rapid changes caused by currents and turbulence. Keep clear of the spillway areas below dams.

Weather/Seas

Getting caught in severe weather is hazardous. It is recommended to check the weather, sea and wind conditions not only before, but also periodically while you are boating.

A change in wave height, wind direction and speed indicates deteriorating weather. Take common sense precautions if you are forced to operate your boat in stormy conditions:

- Wear PFDs.
- Reduce speed and head for a safe place that you can easily reach.
- If you lose power, keep the boat headed into the waves by using the anchor.

It is best to avoid operating your boat in foggy weather. When fog sets in take bearings and log courses and speeds. You are required to emit a five-second blast from your horn or whistle once every minute. Additionally, have passengers wear PFDs and observe for oncoming watercrafts.



Section I

W
A
R
N
I
N
G
M
A
R
K
E
R
S

Warning Markers

DIVERS FLAG

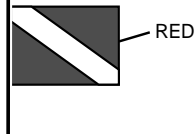

USED BY RECREATIONAL DIVERS - INDICATES DIVER'S POSITION

ALPHA FLAG

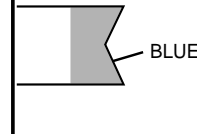

WORLDWIDE VESSELS ENGAGED IN DIVING OPERATIONS - DOES NOT INDICATE DIVER'S POSITION

DISTRESS FLAG

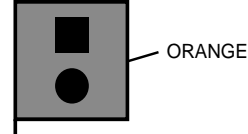

INDICATES FELLOW BOATER IS IN NEED OF ASSISTANCE

KC-0352C-a

Warning Markers

It is a good idea to ask local authorities if there are hazardous areas and how they are marked. Boaters must also recognize the flag designs which indicate that skin divers are present and keep well clear of the area.

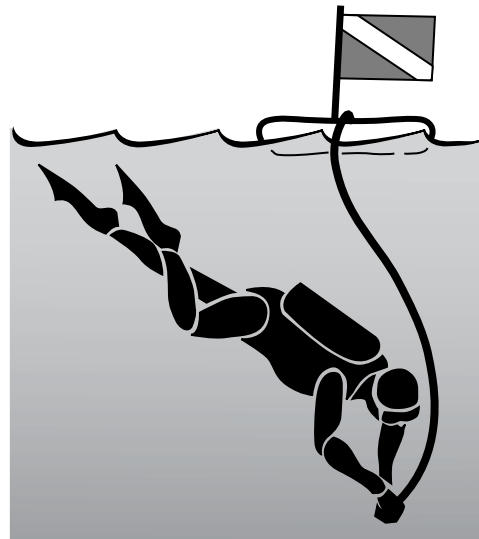

KC-0250C

Skin Diver Warning Flag

Watch for swimmers. Swimming areas may not be marked. Steer clear from the area and remain alert.



Boating Safety



KC-0260C

Swim Area Warning Buoy

Navigation markers serve as a means of identifying navigable routes, and indicate water hazards. Boaters should become familiar with navigation markers and stay within marked boundaries and clear of hazards.

Carbon Monoxide



Carbon Monoxide (CO) is a colorless and odorless gas produced by all engines and fuel burning appliances. Even with the best boat design and construction, plus the utmost care in inspection, operation, and maintenance, hazardous levels of CO may still be present in accommodation spaces under certain conditions.

! DANGER !

EXTREME HAZARD – Carbon monoxide gas (CO) is colorless, odorless and extremely dangerous. All engines and fuel burning appliances produce CO as exhaust as a byproduct of combustion. Direct and prolonged exposure to CO will cause BRAIN DAMAGE or DEATH. Signs of exposure to CO include nausea, dizziness and drowsiness.

Have a suspected CO victim deeply breathe fresh air and immediately seek medical attention.



Section I

OPERATION

Our Environment

As a boater, you already appreciate nature's beauty and the peace of the great outdoors. It is a boater's responsibility to protect the natural environment by keeping waterways clean.

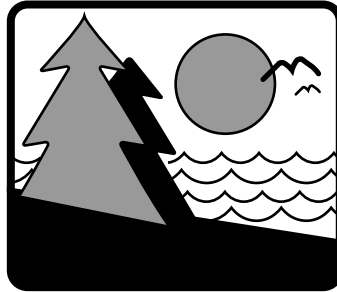

Foreign Species

If you trailer your boat from lake to lake, you may unknowingly introduce a foreign aquatic species from one lake to the next. Thoroughly clean the boat and trailer below the water line, remove all weeds and algae, and drain the bilge before launching the boat in a new body of water.

Fuel/Oil Spillage



WARNING

Fumes from rags can collect in bilge and be extremely hazardous. Do not store rags used to wipe up fuel or solvent spills in the boat. Dispose of rags properly ashore.

The spilling of fuel or oil into our waterways contaminates the environment and is dangerous to wildlife. Do not discharge or dispose of fuel, oil or other chemicals into the water; it is prohibited and you can be fined. These are two common, accidental types of discharge:

- Overfilling the fuel tanks
- Pumping contaminated bilge water



Boating Safety

Discharge/Disposal of Waste

Waste means all forms of garbage, plastics, recyclables, food, wood, detergents, sewage, and even fish parts in certain waters – in short, nearly everything. We recommend you bring back everything you take out with you for proper disposal ashore.

Excessive Noise

Noise means engine noise, radio noise or even voices. Many bodies of water have adopted noise limits. Music and loud conversation can carry a considerable distance on water, especially at night. Be sure to follow regulations and be courteous.

Wake/Wash



WARNING

You are responsible for injury and damage caused by your wake/wash.

Be alert for NO WAKE zones. Prior to entering a no wake zone, come off plane to the slowest steerable speed. Use caution when operating around smaller crafts, in channels and marinas, and in congested areas.

Exhaust Emissions

Increased exhaust (hydrocarbon) emissions pollute our water and air. Keep your engine tuned and boat hull clean for peak performance. Consult your Correct Craft dealer for information.

Paints

If your boat is kept in water where marine growth is a problem, the use of anti-fouling paint may reduce the growth rate. Be aware of environmental regulations that may govern your paint choice. Contact your local boating authorities for information.

2003
CORRECT CRAFT
Nautique



Section I

REGISTRATION

Cleaning Agents

Household cleaners should be used sparingly and not discharged into waterways. **DO NOT** mix cleaners and be sure to use plenty of ventilation in enclosed areas. **DO NOT** use products which contain phosphates, chlorine, solvents, non-biodegradable or petroleum based products. Citrus-based cleaners are excellent for marine cleaning purposes and are safe for you and the environment.

MARPOL Treaty

The USCG enforces the International Convention for the Prevention of Pollution from ships, commonly referred to as the MARPOL Treaty (MARine POLLution). This treaty prohibits the overboard dumping of all ship-generated plastics, chemicals, garbage and oil.

Water Sport Safety

Skiers or riders are obligated to be aware of the same fundamental safety rules as operators. If you are new to water skiing, seek certified training before starting. You will find it especially helpful to join a local ski club, World Wakeboard Association and/or the USA Water Ski, when possible.

Always remember that the majority of water skiing injuries are the result of impacts with other objects. Always look where you are going and be aware of what is going on around you.

Teak/Drag Surfing

READ, UNDERSTAND and be **FAMILIAR** with the information contained on warning labels and adhere to the boat operation practices described on them. The United States Coast Guard issued a **SAFETY ALERT** on August 28, 2001 that covers some of the issues of improper use of the boarding platform. The **SAFETY ALERT** and portions of the accompanying information follow:



Boating Safety

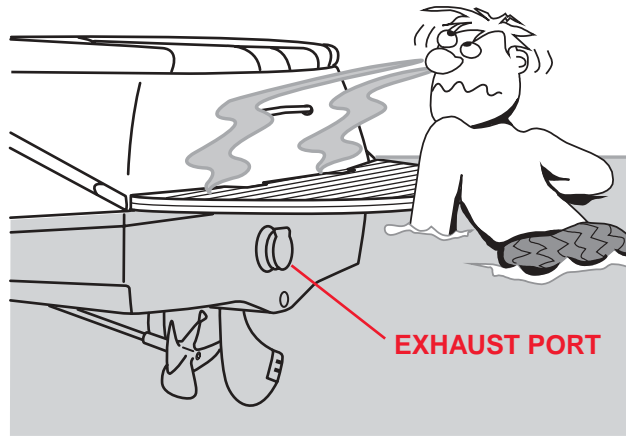

CORC023

Every year tragic deaths occur from the negligence of unsafe boating and dangerous activities. Experts say, "many of these deaths may have been caused by an invisible hazard, carbon monoxide poisoning." Taking the risk of swimming under a boarding platform when the engine is running, skiing within 20 feet (6.1 meters), "teak surfing" or "dragging" behind a moving boat can be fatal. Correct Craft DOES NOT consider any dangerous activities which can result in a serious injury or death a water sport. Correct Craft is concerned for all boaters safety and does not promote unsafe boating risks or jeopardizing any boaters safety.

DO NOT use the boarding platform for any other purpose than boarding the boat or preparation of entering the water, and DO NOT use the boarding platform when the engine is running.

NEPTUNE



Section I

**W
A
R
N
I
N
G**

SAFETY ALERT From August 28, 2001:

The United States Coast Guard advised boaters not to "Teak/Drag Surf." Recent boating fatalities revealed that carbon monoxide (CO) emitted from a vessel's exhaust resulted in CO poisoning and the death of at least six teak surfers. "Teak/Drag Surfing" places the individual in position directly exposed to the CO in the engine's exhaust. This may result in a loss of coherent responses and even death. In addition, "Teak/Drag Surfing" dangerously exposes the individual to a possible propeller injury, and since it is done without a life jacket (PFD), it significantly increases the probability of drowning. Therefore, the Coast Guard stresses, "Teak/Drag Surfing" is a very dangerous activity and advises boaters not to participate in it.

The Coast Guard pointed out that carbon monoxide is one of the most dangerous gases. It strikes before you know you are exposed and it impairs in a way that can and too often does lead to death. That is why it is so important to the Coast Guard that in every circumstance where it can be avoided, it is.

General Water Sport Precautions

- **DO NOT ski in shallow water, close to shore or in water where you do not know the depth or what is beneath the surface.**
- **DO NOT put your arm, head, or any other part of your body through the handle-bridle of the ski line nor wrap the line around any part of the body at any time.**
- **DO NOT ski at night or directly in front of other boats.**
- **DO NOT jump from a boat that is moving at any speed, nor enter or exit the water when the engine is running (RUN).**
- **DO NOT approach the boat if the engine is running.**
- **DO NOT ski near swimming areas, beaches or personal watercraft.**
- **DO NOT follow directly behind another boat or skier without leaving an adequate safe distance.**
- **DO NOT "back up" to anyone in the water.**
- **DO NOT ski with multiple skiers with different length ropes.**
- **DO NOT ski in limited visibility conditions.**
- **DO NOT approach the rear of the boat while the engine is running.**



Boating Safety

- **Make sure that everyone knows and uses approved skiing hand signals and common skiing courtesy.**
- **Be sure to turn off the engine before allowing anyone to approach the boat.**
- **The engine must be shut down (OFF) before a skier enters or exits the boat, boarding platform or ladder.**
- **Every skier must always wear a USCG-approved Type III personal flotation device. Special PFDs are available for high impact falls into the water.**
- **Maintain a distance of at least 100 feet from all other objects, including other boats, piers, rafts, mooring and navigational buoys, pilings, abutments or any other items.**
- **Be sure to have an experienced operator and observer in the boat when skiing.**
- **Look before you turn the boat to pick up a fallen skier.**
- **Have ship to shore communication devices if operating at a significant distance off shore.**
- **The operator should never retrieve or pick up an article from the water while the engine is running. The engine must be shut OFF.**
- **The operator should always keep the skier in view when the skier is entering or exiting the boat.**
- **Communicate skiing speed with the skier before starting.**
- **The operator should know the ability level of the skier.**
- **The skier should indicate he/she is clear of the boat prior to starting the boat or putting the boat into gear and tightening the rope.**
- **The operator, observer and skier should agree to communication hand signals before starting.**
- **Observer in the boat should keep operator appraised of skier status.**
- **The operator should always watch the skier as the line is tightened to start (in case rope wraps around ski or skier).**
- **The operator should look ahead before starting.**
- **Start from a safe place with good forward and peripheral visibility.**
- **The operator should check direction of the rudder before starting (in gear, slowly making sure the boat goes straight).**



Section I



- The operator should be primarily aware of what is occurring in front of the boat, but be aware of skier's progress.
- Be sure to inspect the tow eye or pylon before use. If there is any evidence of corrosion or other damage, do not use until it has been inspected by your Correct Craft dealer.
- Be sure to wear wet suits or protective shorts when skiing to prevent abrasions, hypothermia and injuries to orifices (rectal and vaginal) from impact with a water surface.
- When people are getting on or off of water sports equipment, always turn the engine off. If boarding water sports equipment from the boat, always do so from the boarding platform.
- Always inspect water sports equipment for wear, fraying, etc., before use. Do not use if they show signs of wear or fraying.
- When approaching a skier, always turn off the engine while it is "in gear." This will keep a wind milling propeller from cutting the skier.
- Be sure to approach a downed skier on the operator's side, keep the skier always in view.
- Display a skier down flag whenever the skier is in the water and not skiing.
- Inspect towline for fraying, unnecessary knots or cuts. Replace when the rope shows signs of wear. **DO NOT** wait for the rope to break before replacing an old rope.
- Be sure to follow the approved towing pattern on each lake.



Boating Safety

When participating in water sports, be safe and courteous and follow these guidelines:

- Be considerate to fishermen and others you share the water with.
- DO NOT perform water sports in congested areas.
- Stay away from navigation markers.
- Stay away from other boats and water sports participants.

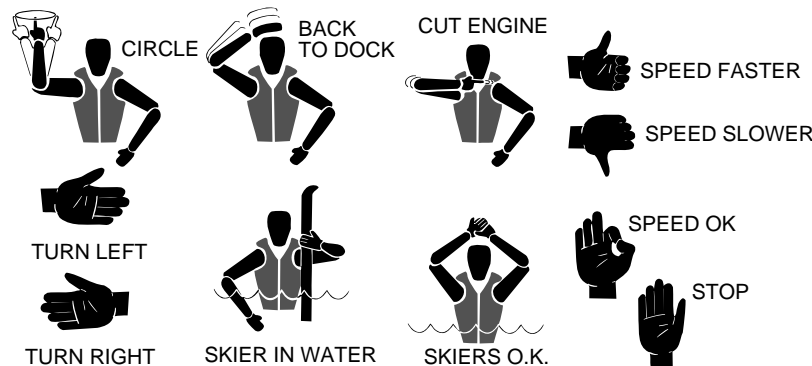

KC-0271C-a

Water Sport Hand Signals

Watersports Responsibility Code

Be aware that there are elements of risk in boating, skiing and riding that common sense and personal awareness can help reduce. Know your ability level and stay within it.

To increase your enjoyment of the sport follow the “Watersports Responsibility Code.”

It is your responsibility to:

- Familiarize yourself with all applicable laws, the risks inherent in the sport, and the proper use of equipment.
- Know the waterways where you will be skiing or riding.
- Do not ski or ride in shallow water, near shore, docks, pilings, swimmers, or other watercraft.
- Always have a person other than the boat driver as an observer and agree on hand signals before starting.
- Always wear a U.S. Coast Guard type III (PFD) vest.



Section I

SAFETY

- Read your owner's manual and inspect your equipment prior to use.
- Ski or ride within your limits.
- Always ski or ride in control and at speeds appropriate for your ability.
- Always turn ignition off when anyone is near watercraft power drive unit.
- Avoid CO poisoning!
- Never drag within 20 feet behind a moving watercraft.
- Do not operate watercraft, ski or ride under the influence of alcohol or drugs.





Section 2

Basic Rules of the Road



WARNING

The nautical “Rules of the Road” must be followed to prevent collisions between boats. Like traffic laws for automobiles, the operator is legally required to follow the rules.

The following information outlines only the most basic of the nautical “Rules of the Road.” For more information, contact your local USCG Auxiliary.

Aids To Navigation

Learn to recognize the different buoys and day markers; they are the signposts of the waterways. There are two primary marking systems in use in the U.S.: the Uniform State Waterway Marking System (USWMS) used on inland waters and maintained by each state, and the Federal Waterway Marking System (FWMS) used on coastal waters and rivers and maintained by the USCG. In addition, the FWMS has two modified systems: the Western River Buoyage, and the Intercoastal Waterway Buoyage. Be sure to check with local authorities on the buoyage system in use.

The type of hazard/warning buoys and markers depends on the area of jurisdiction. Check with local boating authorities.

The only buoys you are permitted to moor to are mooring buoys. Mooring to a navigation buoy or other navigational aid or regulatory marker is illegal.

Section 2



KC-0412C

Mooring Buoy – White with Blue Band May Show White Reflector or Light

USWMS System

In the USWMS Lateral System, well-defined channels are marked with red and black buoys. Lateral means the sides of the channel are marked and the boat should pass between them.

The USWMS Cardinal System is used when there is no well-defined channel or where an obstruction may be approached from more than one direction. With the cardinal system:

- Pass north or east of **BLACK-TOPPED WHITE** buoy.
- Pass south or west of **RED-TOPPED WHITE** buoy.
- **RED and WHITE VERTICALLY STRIPED** buoy indicates boat should pass outside of the buoy (away from shore).



Basic Rules of the Road

Uniform State Regulatory Markers

USWMS regulatory markers are white with international orange geometric shapes; you must obey regulatory markers.

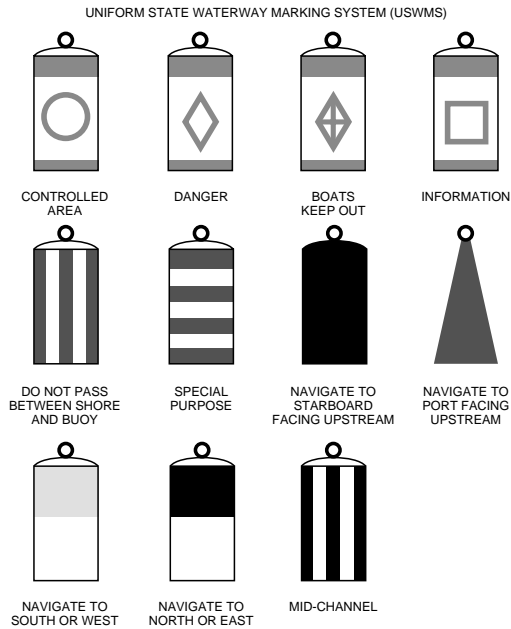

KC-0411C

Uniform State Waterway Marking System (USWMS)

FWMS System

The FWMS Lateral System is for use on navigable waters except Western Rivers and Intercoastal Waterways.

The markings on these buoys are oriented from the perspective of being entered from seaward (the boater is going toward the port). This means that red buoys are passed on the starboard (right) side of the vessel when proceeding from open water into port, and green buoys to the port (left) side.

The right side (starboard) of the channel is marked with RED, even numbered buoys. The left (port) side of the channel is marked with GREEN, odd numbered buoys.



Section 2

SECTION 2



UNLIGHTED
BELL BUOY



SPAR BUOY

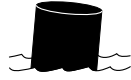

CAN BUOY



LIGHTED BUOY

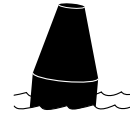

NUN BUOY

KC-042

FWMS Marking System

The middle of the channel is marked with RED and WHITE vertically striped buoys; pass close to these buoys.



SPHERICAL SAFE
WATER MARKER

KC-0430

Spherical Safe Water Marker

Obstructions, channel junctions, etc. are marked with RED and GREEN horizontally striped buoys.

A RED band at the top means the preferred channel is to the left of the buoy; a GREEN top band means the preferred channel is to the right of the buoy.

Day markers are colored and numbered the same as buoys. RED, triangular day markers with even numbers mark the starboard side of the channel. GREEN, square day markers with odd numbers mark the port side of the channel.



Basic Rules of the Road

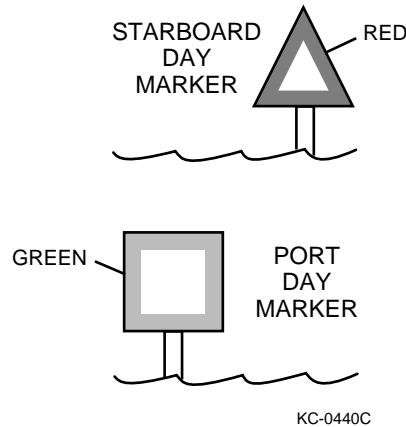

Lights, bells and horns are used on buoys for night or poor visibility conditions. Buoys with unique light flashing characteristics are identified on nautical charts with the specific flashing pattern.

Right-of-Way

NOTICE

In general, boats with less maneuverability have right-of-way over more agile craft. You must stay clear of the vessel with right-of-way and pass to his stern.

Privileged Boats

Privileged boats have right-of-way and can hold course and speed. Sailboats and boats paddled or rowed have the right-of-way over motor boats. Sailboats under power are considered motorboats. Small pleasure craft must yield to large commercial boats in narrow channels.

Burdened Boats

The burdened boat is the boat that must make whatever adjustment to course and speed necessary to keep out of the way of the privileged boat.



Section 2

NAUTIQUE

Crossing Situation

In crossing situations, the boat to the right from the 12 o'clock to the 4 o'clock position has the right-of-way. It must hold course and speed. The burdened boat keeps clear and passes behind the privileged boat. Boats going up and down a river have the privilege over boats crossing the river.

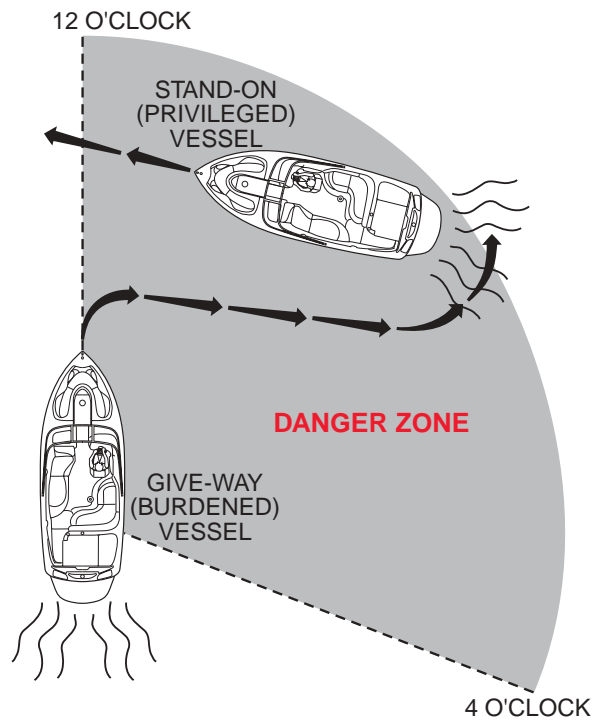

CORC017

Crossing



Basic Rules of the Road

Meeting Head-On

Neither boat has the right-of-way in this situation. Both boats should decrease speed, turn to the right, and pass port-to-port. However, if both boats are on the left side of the channel, each vessel should sound two short blasts and pass starboard-to-starboard.

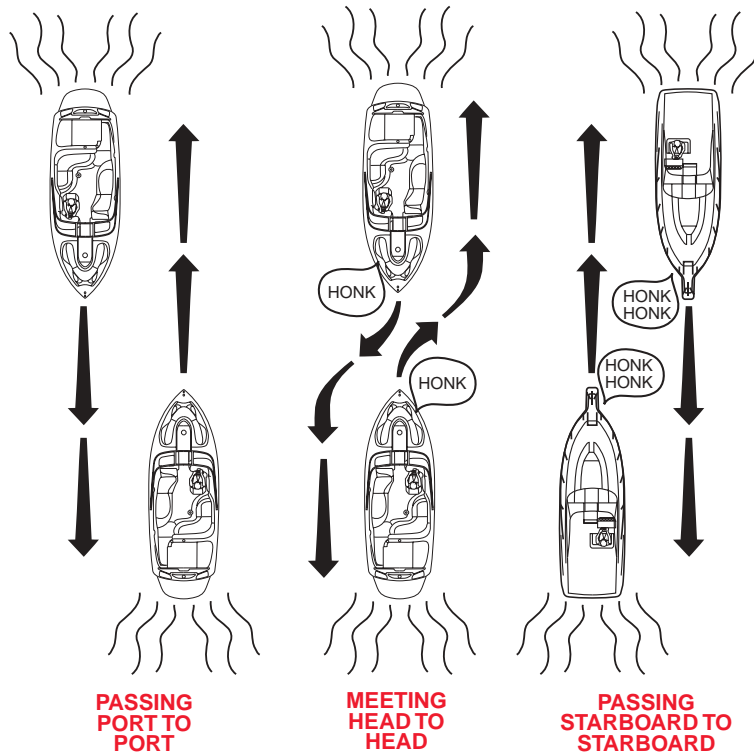

Meeting Head-On

CORC018



Section 2

NAUTIQUE

Overtaking

The boat that is overtaking one ahead of it is the give-way boat and must make any adjustments necessary to keep out of the way of the stand-on boat. The stand-on boat should hold its course and speed.

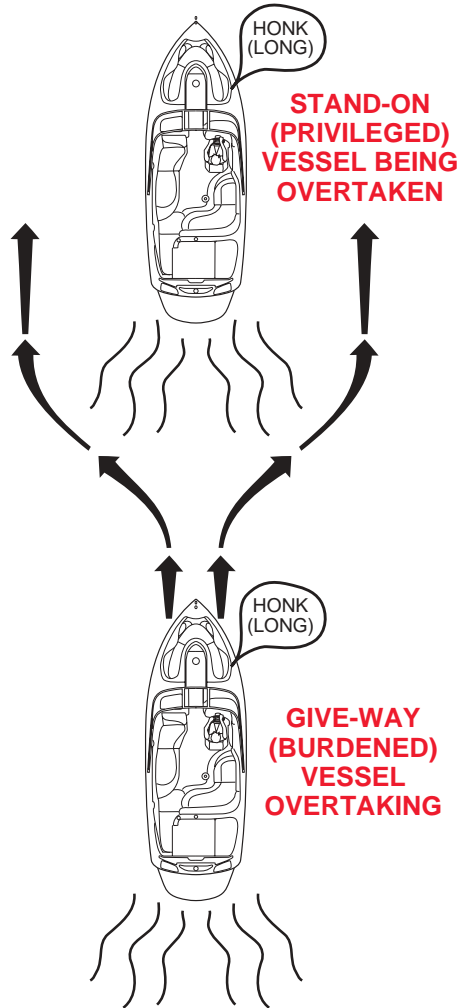

CORC019

Overtaking



Basic Rules of the Road

The General Prudential Rule

The General Prudential Rule regarding right-of-way is that if a collision appears unavoidable, neither boat has right-of-way. As prescribed in the "Rules of the Road," both boats must act to avoid collision.

Night Running

Boats operating between sunset and sunrise (hours vary by state) must use navigational lights. Nighttime operation, especially during bad weather or fog can be dangerous. All "Rules of the Road" apply at night, but it is best to slow down and stay clear of all boats, regardless of who has right-of-way. Protect your night vision by avoiding bright lights and have a passenger, if possible, help keep watch for other boats, water hazards and aids to navigation.

NAUTIQUE



Section 2

NAUTIQUE



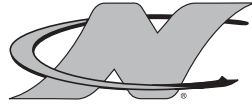

Section 3 196 and 206 Ski

Specifications

196 Ski

Length with Platform.....	21' 2" (6.45 m)
Length without Platform.....	19' 6" (5.94 m)
Lifting Rings (distance between centers)	18' 2" (5.54 m)
Beam.....	91" (2.31 m)
Draft.....	22" (.56 m)
Fuel Capacity	29 Gallons (109.8 l)
Approximate Weight.....	2570 lbs (1170 kg)
Maximum Weight.....	6 People (1210 lbs/550 kg)
Transmission Ratio.....	1.23:1

206 Ski

Length with Platform.....	22' 4" (6.81 m)
Length without Platform.....	20' 7.5" (6.29 m)
Lifting Rings (distance between centers)	19' 6.5" (5.96 m)
Beam.....	91" (2.31 m)
Draft.....	24" (.61 m)
Fuel Capacity	29 Gallons (109.8 l)
Approximate Weight.....	2975 lbs (1352 kg)
Maximum Weight.....	9 People (1210 lbs/550 kg)
Transmission Ratio.....	1.23:1

206
196

Section 3

NAUTIQUE

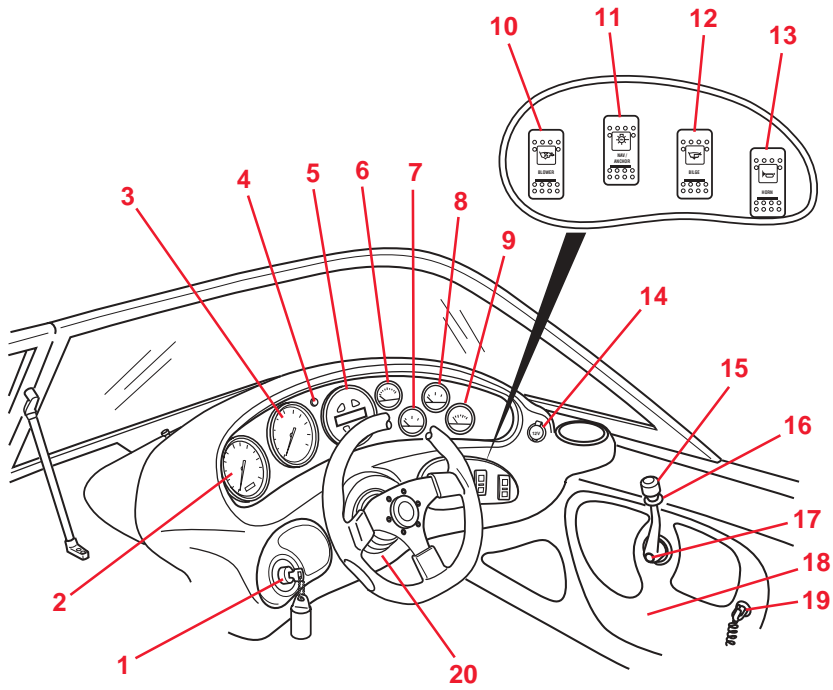

CORC081



I96 and 206 Ski

Standard Dash Pod and Console

1. Ignition Switch
2. Tachometer
3. Speedometer
4. Check Engine Light
5. PerfectPass (optional)
6. Oil Gauge
7. Fuel Gauge
8. Engine Temperature Gauge
9. Voltage Gauge
10. Engine Compartment / Bilge Area Blower Switch
11. Navigation / Anchor Light Switch
12. Bilge Pump(s) Switch
13. Horn Switch
14. 12 Volt Port
15. Shifter/Throttle Control Handle
16. Shift Lock-out Ring
17. Transmission Disengagement Button
18. Ballast Tank(s) Level (optional) – not shown
19. Emergency Stop Switch
20. Steering Wheel Tilt Lever

NOTICE

*A full description of the gauges and switches and their functions is discussed in **Section 4**.*

206 I96



Section 3

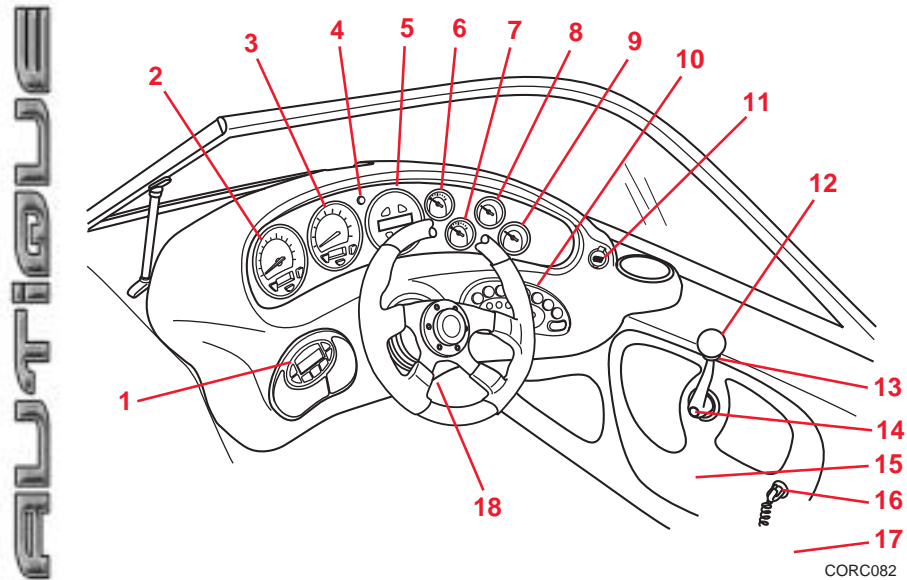

Optional Dash Pod and Console

1. Digital Stereo Remote w/clock
2. Tachometer
3. Speedometer
4. Check Engine Light
5. PerfectPass (optional)
6. Oil Gauge
7. Fuel Gauge
8. Engine Temperature Gauge
9. Voltage Gauge
10. Ignition and Switch Panel – refer to Ignition and Switch Panel in this section
11. 12 Volt Port
12. Shifter /Throttle Control Handle
13. Shift Lock-out Ring
14. Transmission Disengagement Button
15. Ballast Tank(s) Level – not shown
16. Emergency Stop Switch
17. Automatic Bilge Panel – not shown
18. Steering Wheel Tilt Lever

NOTICE

A full description of the gauges and switches and their functions is discussed in Section 4.



I96 and 206 Ski

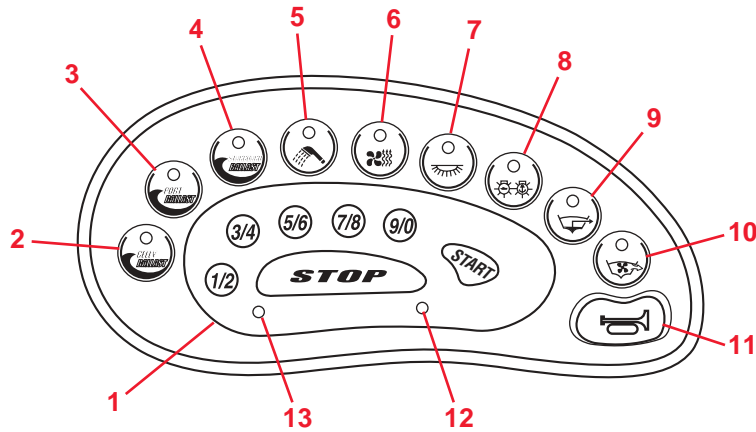

CORC083

Optional Ignition and Switch Panel

1. Keyless Ignition Key Pad
2. Belly Ballast (rear ballast tank on Ski models)
3. Port Ballast – Not applicable
4. Starboard Ballast – Not applicable
5. Shower Pump
6. Heater Fan
7. Courtesy Lights / Docking Lights
8. Navigation / Anchor Lights
9. Bilge Pump(s)
10. Engine Compartment / Bilge Area Blower
11. Horn
12. System Indicator Light
13. Ignition Indicator Light

NOTICE

*If your boat is not equipped with the features on the Ignition and Switch Panel Switch buttons, the button will not have a function. A full description of the key pad keys and switch buttons and their functions is discussed in **Section 4**.*



Section 3

NAUTIQUE

196 Ski Deck Layout

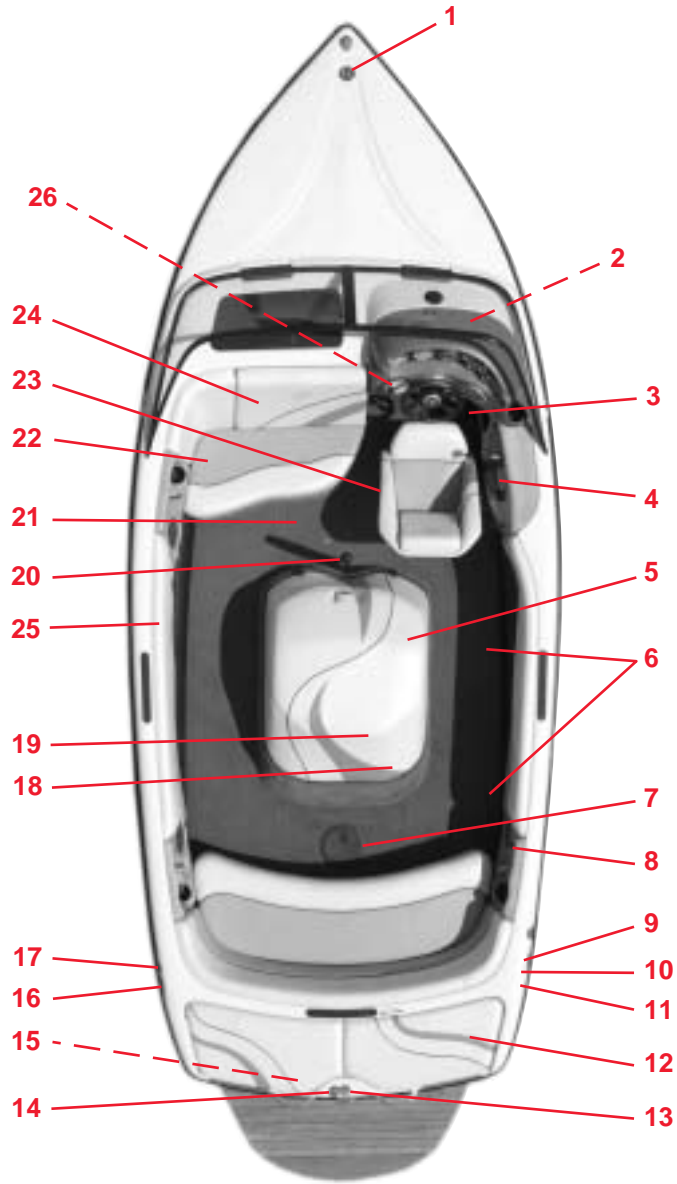

CORC080



196 and 206 Ski

196 Ski

Description

1. Bow Lifting Ring
2. SE Speedometer Calibration Adjustment
(under deck near driver's right knee)
3. Dash Pod
4. Console
5. Engine Cover
6. Optional Board Racks - not shown
7. Propeller Shaft Stuffing Box
8. Optional 12V Port and Speaker Pod
9. Fuel Tank Fill
10. Ballast Tank Drain (if equipped)
11. Bilge Drain
12. Storage Trunk
13. Stern Lifting Ring
14. Anchor Light Receptacle
15. Rudder Shaft Remote Lube Fitting
(optional, standard with ballast tank)
16. Fuel Tank Vent
17. Fuel Tank Fill
18. Engine Cooling Water Intake Shut-off Valve
19. Engine Cooling Water Strainer
20. Tow Pylon
21. Floor Cooler w/removable Tray
22. Love Seat / Bow Storage Access
23. Operator's Seat Adjustment
24. Glove Box
25. Anchor Light Storage
26. Ballast Tank Valve (if equipped)

NOTICE

The battery is located in the floor, in front of the in-floor cooler.



Section 3

NAUTIQUE

206 Ski Deck Layout

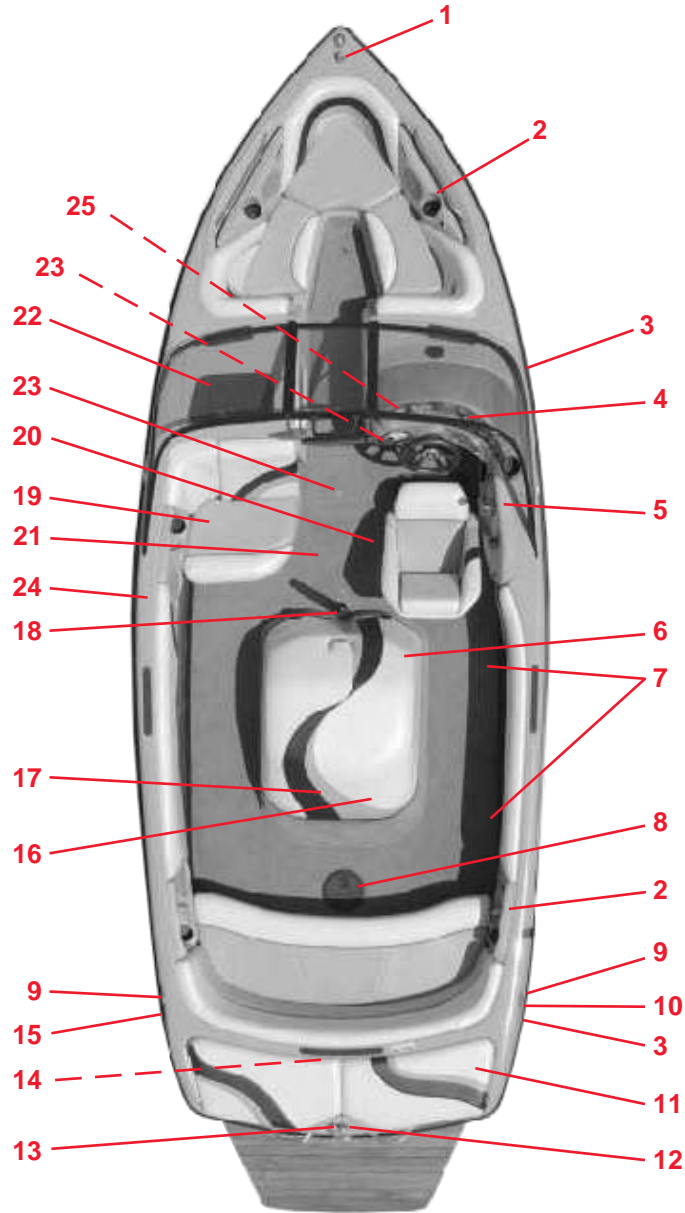

CORC079



196 and 206 Ski

206 Ski

Description

1. Bow Lifting Ring
2. Optional 12V Port and Speaker Pod
3. Bilge Drain
4. Dash Pod
5. Console
6. Engine Cover
7. Optional Board Racks - not shown
8. Propeller Shaft Stuffing Box
9. Fuel Tank Fill
10. Ballast Tank Drain (if equipped)
11. Storage Trunk
12. Stern Lifting Ring
13. Anchor Light Receptacle
14. Rudder Shaft Remote Lube Fitting (optional, standard with ballast tank)
15. Fuel Tank Vent
16. Engine Cooling Water Intake Shut-off Valve
17. Engine Cooling Water Strainer
18. Tow Pylon
19. Love Seat / Storage Access
20. Operator's Seat Adjustment
21. Service Box (battery*, bilge pump, T-handle drain)
22. Glove Box
23. Floor Cooler w/removable Tray
24. Anchor Light Storage
25. Ballast Tank Valve (if equipped)

* The battery is located in the floor, in front of the engine cover.

206



Section 3



Standard and Optional Equipment

Correct Craft boats are equipped with only the finest standard and optional equipment available. Your boat's equipment will vary, based on how your boat was built. Many options can only be installed during the manufacturing of the boat and cannot be retrofitted to boats in the field.

Not all of the standard or optional equipment's use, safety and maintenance information can be covered in this manual. You will find most of the standard and optional equipment in this manual in the section pertaining to its use and function in **Section 4**. Make sure you read and understand this manual and all the other manufacturers' literature provided in your Skipper's Kit to maximize the benefits and uses this equipment has to offer.

If you have any questions regarding the use of any equipment on your Correct Craft boat, contact your Correct Craft dealer.





Section 4 Controls and Indicators

Knowing the systems, controls and indicators on your boat is essential for safe and proper operation.



WARNING

Improperly maintained controls are hazardous and may cause sudden loss of control. Make sure all steering and shift/throttle hardware, cables and fluid levels are regularly inspected and maintained. Improper maintenance may result in a loss of control, possibly causing serious injury or death.

Steering

The steering system in your Correct Craft boat provides excellent maneuvering performance for pleasure boating or during water sports. Boat steering is not self-centering. Always keep a secure grip on the steering wheel to maintain full boat control. The steering wheel is equipped with a tilt lever to adjust the wheel angle to a comfortable operating position when the boat is not moving.

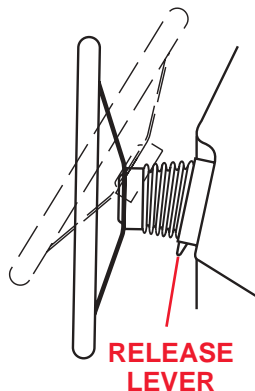

CORC133

Section 4



The helm transfers rotary motion of the steering wheel to linear motion in the cable which pushes or pulls the rudder. Nautique rudders are equipped with an adjustable trim tab under license from Z-Marine (U.S. patent 5,746,147) to compensate for the torque generated by the propeller.

Maintenance for the steering system is minimal because there are few serviceable parts. The rack and pinion for the system is lubricated and sealed during manufacturing. It is the responsibility of the owner/operator to inspect the steering system frequently.

If you experience difficulty in steering, refer to Section 8 - Care and Maintenance.

! WARNING An out of control boat could cause injury or death. DO NOT operate your boat if you suspect the steering system is malfunctioning. Have your Correct Craft Dealer investigate any steering system irregularities immediately.



Controls and Indicators

Shifter/Throttle

WARNING

Your Correct Craft boat is equipped with a Shifter/Throttle Control Handle which features a start-in-gear protection to prevent the boat from moving when started. Never replace the control with a control that does not have this feature.

A single-lever control with neutral lockout button and safety collar operates as both a gear shifter and a throttle control. When the throttle lever is vertical, it is locked in the NEUTRAL position for safety. Be sure the control is in NEUTRAL before attempting to start the engine. Lifting the safety collar and moving the throttle lever forward will engage FORWARD gear in the transmission and increase the engine RPM. Moving the throttle lever backward will engage REVERSE gear in the transmission and also increase the engine RPM.

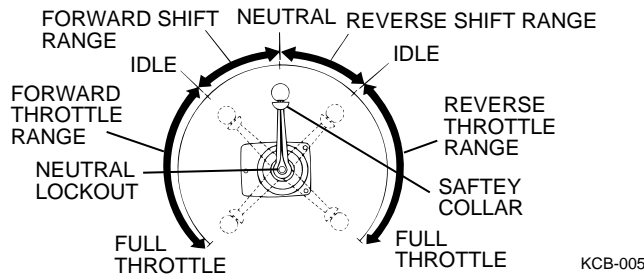

CAUTION

DO NOT shift too quickly from FORWARD to REVERSE. Stay in NEUTRAL, or idle position until the boat has lost most of its headway before completing the shift to REVERSE or engine/transmission damage may occur.

Nautique



Section 4

Nautique

Emergency Stop Switch

The emergency stop switch and lanyard will stop the engine in case of an emergency. Attach the lanyard to the boat operator whenever the engine is running but be aware there will be a loss of boat control if the switch is activated. If the operator is thrown from the seat or moves too far from the helm, the lanyard will become disconnected from the switch, shutting off the engine. Refer to Section 1 for more information.

CAUTION DO NOT allow your boat to be operated without the proper use of the emergency stop switch and lanyard.

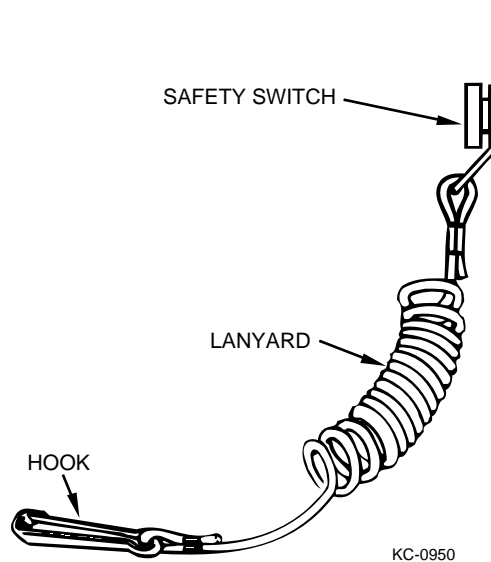

To attach a lanyard, connect the clip to the emergency stop switch and the hook to a strong piece of clothing on the operator, such as a belt loop.

NOTICE

The engine will not start unless the emergency stop switch is attached.



Controls and Indicators



WARNING

Attach the lanyard to the operator before starting the engine. This will prevent the boat from becoming a runaway if the operator is accidentally thrown from the helm. The emergency stop switch can only be effective when it is in good working condition. Observe the following:

- DO NOT remove or modify an emergency stop switch and/or its lanyard.
- The lanyard must be free from obstructions that could interfere with its operation.

Once a month: Check the emergency stop switch for proper operation. With the engine running, pull lanyard. If the engine does not stop, see your Correct Craft Dealer for service of the switch.

SE Dash Pod

Gauges

- **Volts** - Indicates the condition of the engine's cranking battery in volts DC. With the ignition switch on and the engine not running, a reading above 12.5 volts indicates a fully charged battery. With the engine running at idle, the gauge should read between 12.5 and 13 volts. With the engine running at cruising speeds and above, it should show 13 to 14.5 volts. Have your Correct Craft Dealer check the charging system if the voltmeter reads outside these normal ranges.

2
3
4
5
6
7
8
9
10
11
12
13
14
15
16
17
18
19
20
21
22
23
24
25
26
27
28
29
30
31
32
33
34
35
36
37
38
39
40
41
42
43
44
45
46
47
48
49
50
51
52
53
54
55
56
57
58
59
60
61
62
63
64
65
66
67
68
69
70
71
72
73
74
75
76
77
78
79
80
81
82
83
84
85
86
87
88
89
90
91
92
93
94
95
96
97
98
99
100



Section 4



- **Temp** - Indicates the engine coolant temperature. Refer to the engine manual for normal operating temperature. After starting the engine, check your temperature gauge for abnormally high readings. If the reading is outside the manufacturer's operating range, immediately turn OFF the engine. An abnormally high temperature indicates a cooling system problem. Consult your Correct Craft dealer when experiencing a high engine temperature reading.
- **Oil Pressure** - Measures the pressure of the engine's lubricating oil. Refer to the engine manual for normal operating pressure. Many serious engine problems are reflected on oil pressure gauge readings. If the pressure is lower than the manufacturer's specification, immediately turn OFF the engine. Contact your Correct Craft Dealer to correct the problem before operating the engine.
- **Tachometer / Hour Meter** - Registers engine speed in revolutions per minute (RPM). Use the tachometer to keep the engine within the proper operating range. Consult the engine manual for the proper RPM operating range of your engine. The hour meter LCD display registers accumulated engine operating time. Time will not be logged unless the ignition switch is on and the engine is running. Use the hour meter to keep accurate logs for scheduled maintenance.
- **Speedometer** - Your Nautique is equipped with a precision speedometer by Faria. This gauge registers forward speed in miles per hour (optional kilometers per hour). The speedometer is equipped with an adjustment knob to calibrate speedometer accuracy. You can also use this gauge to monitor fuel consumption and propeller performance.
- **Engine Warning Light** - Indicates high engine temperature. If light illuminates, stop engine and investigate for cause.



Controls and Indicators

Speedometer Calibration

The speedometer calibration control knob is located on the under side of the deck beneath the dash pod above the driver's right knee. Drive the boat at a known speed using a GPS or measured course and adjust the knob until the speedometer is reading correctly. Turning the knob one direction will raise the needle reading while turning it in the other direction will lower the reading.

Control Switches

Each electrical circuit on your boat is equipped with a control switch. The switches have an indicator light for easy ON/OFF identification. All switches are fuse protected.



Engine Compartment / Bilge Area Blower

The "BLOWER" switch activates the engine compartment ventilation blower to remove explosive fumes from the area. The blower must be operated for a minimum of four minutes each time before starting the engines or generator. In addition, the blower should be operated continuously when at idle or running at slow speeds.



WARNING

Gasoline vapors can explode resulting in injury or death. Before engine start-up, check engine compartment for gasoline vapors, then operate blower for at least four minutes. Operate blower whenever below planing speed.



WARNING

Failure to operate the blower can lead to conditions favorable for an explosion which can cause severe personal injury or death.



Section 4

OPERATION



Navigation Lights

The “NAV/ANCHOR” switch controls the navigation lights. The law requires the bow light and the 360 degree light (located near the stern) be turned on while running the boat after sunset or before dawn. NAV position will turn on the red and green navigation bow lights, 360 degree white stern light and gauge illumination.



Anchor Light

The “NAV/ANCHOR” switch turns on the 360 degree light. Insert this light pole into the receptacle located near the stern and push the anchor switch on the pod to turn this light on. This light is required by law to be on after sunset and before dawn when the boat is not moving.



Bilge Pump

The “BILGE” switch turns on the bilge pump to remove excess water from the bottom of the boat. There is a bilge pump near the rudder and one in the front of the 206 Ski. When you turn the switch on, the pump(s) will operate and run for several moments to “sense” if there is water in the bilge. If there is water in the bilge, the pump(s) remains on until the water is pumped out. If there is no water in the bilge, the pump(s) will turn off. If you want immediate pump action, turn the switch off and then back on again. The pump(s) will turn on periodically to determine if there is water in the bilge. If so, they will remain on until the water is pumped out.

The bilge switch must be turned on for this feature to operate. This will not drain significant power from the battery unless the bilge pump(s) is required to run frequently because of a leak or excessive rainwater. This pumping system should not be relied on over an extended period of time. Frequently inspect your boat for evidence of excessive water in the bilge area. Consult your Correct Craft dealer if you have any questions.



Controls and Indicators

NOTICE

Trash in bilge area can damage the bilge pumps.

Horn

The "HORN" button is a momentary switch. The horn will operate whenever the button is pressed and will stop when the button is released.

Engine Warning Light

This light indicates high engine temperature or low engine oil pressure. The light should come on when the ignition switch is in the ON position and the engine is not running. If it stays on or comes on while you are operating the boat, the light is indicating a problem - turn. Refer to the engine manual for additional information.

12 Volt Port

This receptacle can be used to power and charge cellular phones, MP3 players, video cameras or other electronics. These receptacles are powered through a 10 amp breaker.

Ignition Keyswitch

This keyswitch starts and stops the engine. A built-in protection system prevents the engine from starting in any gear other than NEUTRAL. Refer to Shifter/Throttle in this section and consult the engine operator's manual for more information.

There is an accessory position on the ignition keyswitch and an associated terminal on the back of the switch provided to control power to add on accessories. Even though power to this terminal is protected by a 20-amp fuse, do not connect any accessory that draws more than 10 amps. Attaching an accessory to this terminal should only be done by a qualified technician.



Section 4

NAUTIQUE

CAUTION

DO NOT connect an accessory drawing more than 10 amps to the keyswitch accessory terminal. Doing so may cause a hazardous situation or damage the electrical system.

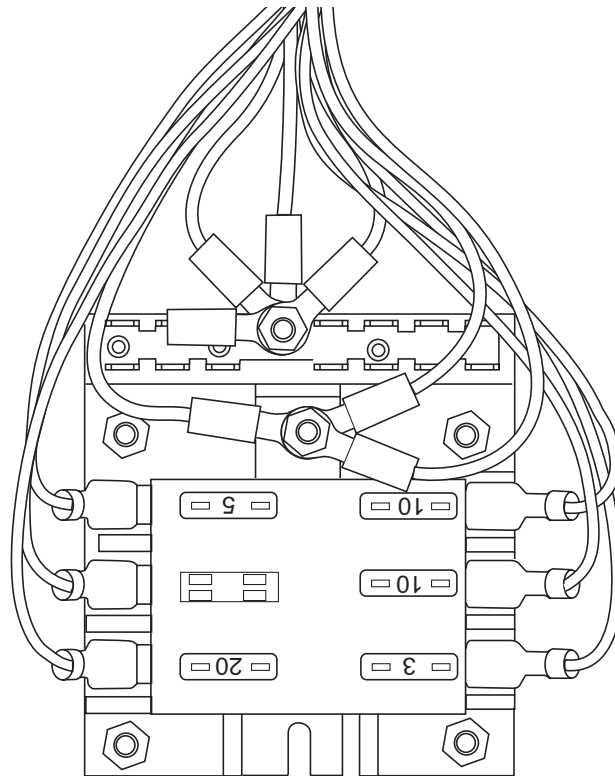

CORC072

Fuse Panel

The fuse panel is located on the under side of the deck beneath the dash pod. Fuses protect the circuit by limiting the amount of current which can flow. If a fuse should "blow", it is usually an indication of a problem, consult your Correct Craft Dealer. Replace a blown fuse with an identical replacement.



Controls and Indicators

CAUTION

DO NOT replace a fuse with one of a different color, size or amperage rating. Doing so may cause a hazardous situation or damage the electrical system.

Dash Pod - LE or Team

OPTIONAL Ignition and Switch Panel

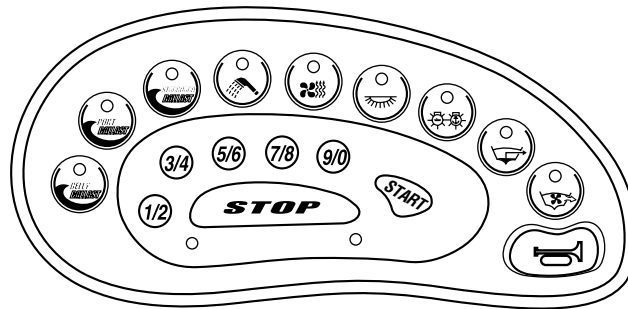

CORC137

Keyless Ignition

The optional ignition switch system is keyless and has three modes of operation.

CAUTION

The keypad and switch control box will be damaged beyond repair if the boat's battery cables, the main switch control box power leads or battery charger leads are reversed. DO NOT reverse these connections.

Locked Mode

When the boat's battery is first connected, the unit is in locked mode. In this mode, only the horn, bilge pump, bilge blower, and code keys operate.



Section 4



Unlocked Mode

Unlocked mode is entered after the user successfully enters the user code, presses, and releases the start key. When the code keys are pressed, the system indicator light will turn ON while the key is pressed. This indicates the key has actually been pressed. When the system is unlocked, power is supplied to the boat and the system indicator light will turn ON. At this point all keypad keys will operate and actuating these keys will control the corresponding boat functions. To put the unit back in Locked Mode, the user must successfully enter the user code, then press the STOP key. When the code keys are pressed, the system indicator light will turn OFF. Power will be shut off to all of the accessories with the exception of the horn, bilge pump, bilge blower and code keys.

Run Mode

Enter the Unlocked Mode.

Pressing and releasing the START key quickly will put the unit in Run Mode. Power is supplied to the engine ignition, but the engine will not crank and the ignition indicator light is turned ON. If the start key is not pressed again within 15 minutes, the unit will exit Run Mode by shutting off power to the ignition and re-enter the Unlocked Mode. If the user presses and holds the START key, power is supplied to the ignition and starter for as long as the user presses the START key. All accessory keys will operate in this mode. Pressing the STOP key will shut off the engine and the unit is then put back in the Unlocked Mode.

After the engine starts, release the START key.

CAUTION

DO NOT hold the START key for more than 30 seconds. The starter motor can be damaged.



Controls and Indicators

Automatic Return to Locked Mode

If no keypad activity takes place for ten hours after unlocking, the system will automatically return to the Locked Mode to help prevent battery drain.

Automatic Back-lighting

Pressing any keypad key will automatically turn the keypad back-lighting on for ten seconds. This feature is useful for finding the keypad at night.

Multiple Keyless Ignition Codes

The keyless ignition system has provisions for three different ignition codes. Any of the three codes may be used to unlock or lock the system.

The “Master Embedded Code” is programmed into the system at Correct Craft Inc. It is not changeable and remains with the boat for its life. This code can be used to unlock the system, to lock the system and to erase the two user codes.

The “Primary User Code” is programmed into the system by the owner with the Correct Craft Dealer’s help at the time of boat delivery. This code is used to unlock the system, to lock the system and to add or change the “Secondary User Code.”

The “Secondary User Code” is programmed into the system by the owner when necessary. This code is only used to unlock or lock the system. The “Secondary User Code” is ideal to limit access to the boat.

NOTICE

To help prevent battery drain, make sure you STOP the engine and LOCK the PME ignition system (two steps) when you are finished using the boat.



Section 4



NOTICE

The "System Indicator Light" is on the right side of the ignition keypad. The "Ignition Indicator Light" is on the left side of the ignition keypad.

Programming the Primary User Code

NOTICE

Until a Primary User Code is set, the keyless ignition does not require the entry of a code to unlock the system or start the engine.

The system operates as follows:

1. Press START to unlock the system.
2. Press it a second time to start the engine.
3. Press STOP to turn off the engine.
4. Press it a second time to lock the system. The system indicator light should be OFF.

To program the Primary User Code, make sure the system indicator light is off, then press the 1/2 key and the 7/8 key at the same time to put the system in the Code Programming Mode. The system indicator light will flash.

Enter a code from two to eight characters and press START. For verification, re-enter the code and press START again. The system indicator light should stop flashing and stay ON. If the light does not stop flashing, press STOP and begin again.

To lock the system, re-enter either the Primary User Code or the Master Embedded Code and press STOP.



Controls and Indicators

Changing the Primary User Code

NOTICE

The current primary code must be used to change to another primary code.

Make sure the system indicator light is OFF.

1. Enter the Primary User Code and press the 1/2 key and the 7/8 key at the same time to put the system in the code programming mode. The system indicator light will flash.
2. Enter a code from two to eight characters and press START. For verification, re-enter the code and press START again. The system indicator light should stop flashing and stay ON. If the light does not stop flashing, press STOP and begin again.

To lock the system, re-enter either the new Primary User Code or the Master Embedded Code and press STOP.

NOTICE

Changing the primary code will erase the Secondary User Code.

Programming or Changing the Secondary User Code

NOTICE

The Secondary User Code will only lock or unlock the system and can not be used for any reprogramming

Make sure the system indicator light is OFF.

1. Enter the primary user code and press the 1/2 key and the 5/6 key at the same time to put the system in Code Programming Mode. The system indicator light will flash.
2. Enter a code from two to eight characters and press START. For verification, re-enter the code and press START again. The system indicator light should stop flashing and stay ON. If the light does not stop flashing, press STOP and begin again.

To lock the system, re-enter any of the three codes and press STOP.



Section 4

1
2
3
4
5
6
7
8
9
10
11
12
13
14
15
16
17
18
19
20
21
22
23
24
25
26
27
28
29
30
31
32
33
34
35
36
37
38
39
40
41
42
43
44
45
46
47
48
49
50
51
52
53
54
55
56
57
58
59
60
61
62
63
64
65
66
67
68
69
70
71
72
73
74
75
76
77
78
79
80
81
82
83
84
85
86
87
88
89
90
91
92
93
94
95
96
97
98
99
100

Erasing the User Codes

Make sure the system indicator light is OFF.

Enter the Master Embedded Code and press the 1/2 key and the 5/6 key at the same time to erase the system user codes.

The keyless ignition will now act as if there are no codes in memory. Pressing the START key will unlock the system and pressing the STOP key will lock it without entering a code. Follow the steps in “Programming The Primary User Code” in this section.

Gauges

The optional dash pod uses the Faria® Serial Bus™ system which receives information from the engine ECU and various individual sensors throughout the boat. This information is transformed into digital data, which is distributed to analog and digital instruments via a single cable consisting of two shielded, twisted pairs of conductors.

Each instrument selects the data, which applies and displays it as if it was received from the sender directly. One of the two pairs of conductors carries the data while the other pair of conductors carries the power for the instruments. The tachometer and speedometer each have three pushbuttons, which allow the different functions of each instrument to be activated.

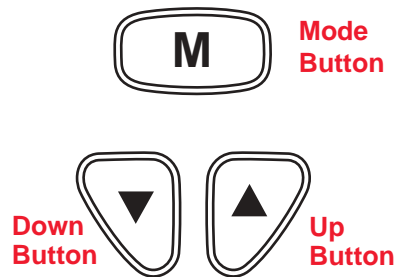

CORC113



Controls and Indicators

Refer to Standard Dash Pod in this section for additional information on gauge operation.

Speedometer / Depth Sounder

The Serial Bus Speedometer / Depth Sounder provides both the functions of a speedometer and a depth sounder. The analog speedometer looks like a standard analog device but is actually a digital instrument. On small pointer movements you may occasionally see the pointer moving in the one-third degree "steps" that represent the accuracy of the instrument.

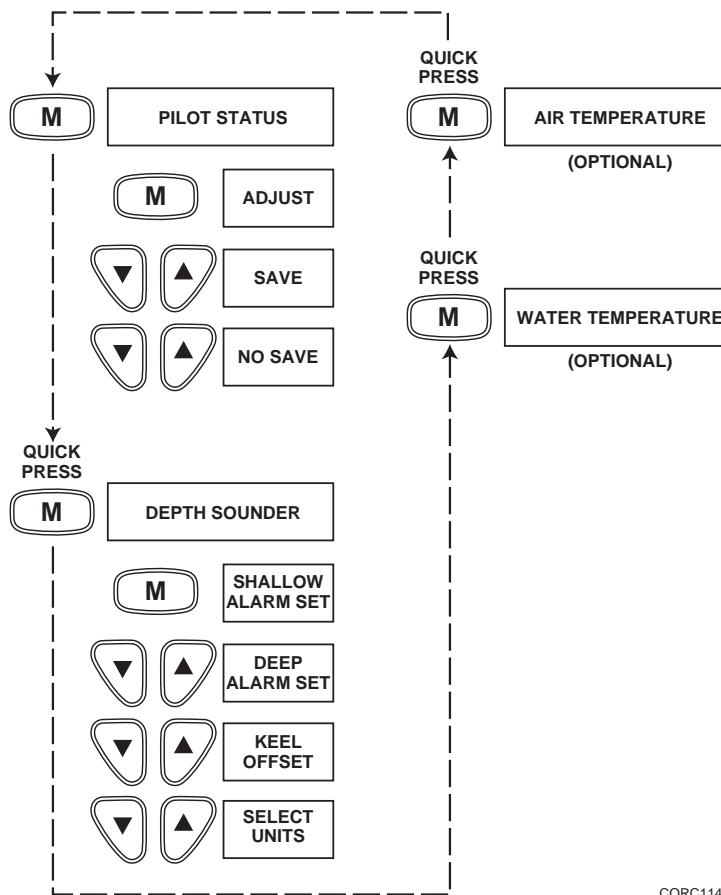

CORC114

Nautique



Section 4

OPERATION

Speedometer Function

The speedometer measures the water pressure in the pitot tubes when power is first turned on. This measurement is subtracted from later readings to correct for the pressure caused by the weight of water over the pitot pick-up.

For maximum accuracy, the boat should not be moving when the key is turned on, especially in a re-start condition. If the boat is moving, the pressure in the pitot will be greater than normal, resulting in the speedometer reading low.

The system is designed to operate with two pitot pick-ups for speed sensing. The speed displayed is based on the pitot with the highest pressure. On the speedometer LCD display, the active pitot sensor will be identified with a "P" or "S." It is normal to see the display switch between the port and starboard pitot sensors, especially in high-speed turns.

Both pitot sensors are continuously monitored, and blockage in either sensor will be detected. If a sensor becomes blocked, the system will switch to the clear pitot sensor. An "XX" will flash in place of the "P" or "S" on the speedometer LCD to indicate which sensor is blocked. Clean the pitot sensor to restore normal operation.

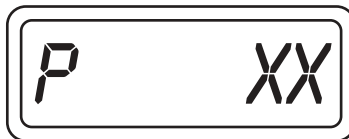

Port Sensor - Starboard Blocked

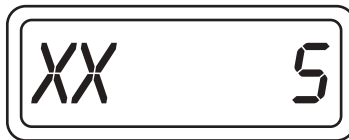

Starboard Sensor - Port Blocked

CORC115



Controls and Indicators

Speedometer Calibration

The analog speedometer displays the speed of the boat through the water. The speedometer is calibrated at the factory however, significant variations can occur due to changes in location. Therefore, the speedometer can be easily calibrated to a known reference such as a radar gun, measured course, or GPS. The LCD will display:



Calibration Display

CORC116

When the unit is operating in normal mode (i.e. pitot status information on the LCD), push and release **M** to put the speedometer in the calibration mode. Push and hold **M** down for at least two seconds, the LCD will show "AdjUST."



Calibration Display

CORC117

Run the boat at a constant 30 MPH as measured by the GPS, radar, or closed course. Adjust the speedometer pointer by pressing ▲ and ▼ until the speedometer matches the known speed.

When finished, press **M** to exit the adjustment screen. The operator has the option of saving or canceling the adjustment procedure. The options can be selected using ▲ and ▼. To save the calibration setting, press and hold **M** for two seconds when the display shows "SAVE."



Section 4

Nautique



Save Display

CORC118

To exit the adjustment procedure without saving, press and hold **M** for two seconds when the display shows “NO SAVE.” Multiple runs in opposite directions may be necessary to compensate for errors due to water currents.

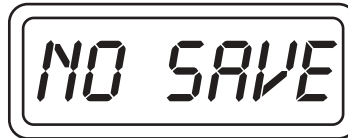

No Save Display

CORC119

Depth Sounder Function

To display depth information on the LCD push and release the **M** until the display shows the depth. The depth sounder is turned on and off with the ignition switch. The depth sounder can also be turned off at any time, while in depth display mode, by pressing and holding **M** while the depth sounder counts down a three second delay.

The depth display will then indicate “OFF.”

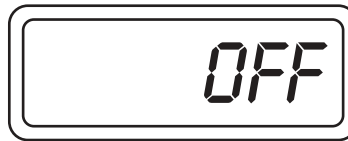

Off Display

CORC120

Press and hold the **M** to turn the depth sounder back on.



Controls and Indicators

When there are no alarm conditions, the water depth is displayed. If the signal is weak or lost, or there is no transducer connected, the display will alternate between the last known depth and three horizontal bars.

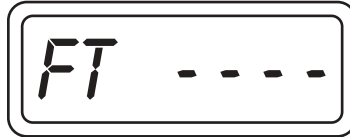

Depth Display

CORC121

Canceling Depth Alarms

A depth alarm warning can be temporarily canceled by pressing both ▲ and ▼ on the speedometer, simultaneously. After one minute, the alarm will resume if the condition that caused the alarm is not corrected. The operator can cancel the alarm as many times as necessary, until the condition is corrected.

The depth alarm warning will replace any information on the LCD screen. Canceling the alarm will restore the LCD to the original display. If not already in the depth mode, this would be a good time to switch to it (using **M**) in order to monitor water depth.

Depth Sounder Alarm Settings

NOTICE

*The speedometer display must be in the depth display mode to change settings. Use the **M** to scroll to the depth display.*

To change the depth sounder alarm settings **M** must be held down until the depth display changes to the alarm settings mode.

There are four menus in the alarm settings mode. Pressing and releasing the mode switch quickly will cycle through the different options.



Section 4

Nautique

Shallow Alarm

This alarm sounds when the water depth equals or is less than the set value.

The display will show “S X.X” which is the current setting for the shallow alarm. Pressing ▲ and ▼ will change the shallow setting.



Shallow Display

CORC122

Holding **M** in for two seconds will save the new shallow setting and change the display back to the normal depth mode. Set to zero to disable the alarm.

Deep Alarm

This alarm sounds when the water depth equals or is greater than the set value.

The display will show “d XX.X” which is the current setting for the deep alarm.



Deep Display

CORC123

Pressing ▲ and ▼ will change the deep setting.

Holding **M** in for two seconds will save the new deep setting and change the display back to the normal depth mode. Set to zero to disable alarm.



Controls and Indicators

Keel Offset

Adjust depth sounder to measure depth below keel or drive instead of sensor.

The display will show “K X.X” which is the current setting for the keel offset. Pressing ▲ and ▼ will change the keel-offset setting.



Keel Display

CORC124

Holding **M** in for two seconds will save the new keel offset setting and change the display back to the normal depth mode. The keel offset is normally a negative number.

Units

Change the unit of measure.

This display will show “UNIT FT” for feet (default), “UNIT FA” for fathoms, or “UNIT M” for meters. Pressing ▲ and ▼ will cycle through the choices. Pressing and holding the **M** will save the units shown in the display and change the display back to the normal depth mode.



Section 4

Nautique



Feet (default)



METERS



FATHOMS

CORC125

Tachometer / Fuel Monitor

The Tachometer / Fuel Monitor provides both the functions of a tachometer and a fuel – engine monitoring system. The analog tachometer looks like a standard analog device but is actually a digital instrument. On smaller pointer movements you may occasionally see the pointer moving in the one-third degree “steps” that represent the accuracy of the instrument.

The tachometer LCD screen displays several user selected functions. The displayed data includes: “engine hours,” “time remaining,” “engine temperature,” “oil pressure,” “system voltage,” and engine alarm conditions.

Pressing the “mode M” button will select the various functions as shown in the Tachometer Display Sequence.

In order to minimize “false” alarms, the “low fuel” and “low voltage” alarms only function when the engine is known to be running based on the presence of tachometer data.



Controls and Indicators

Several alarm conditions may also be displayed in the LCD display when needed:

1. Low fuel
2. Low oil pressure
3. High engine temperature
4. Low voltage
5. Engine RPM reduction due to engine controller command
6. RPM limit
7. Knock sensing system malfunction
8. Ignition system malfunction
9. Manifold pressure sensor (MAP) malfunction
10. Manifold temperature sensor malfunction
11. Throttle position sensor (TPS)
12. Cooler sensor malfunction

Alarm messages will be displayed on the tachometer LCD. Messages 1 through 5 will also include a flashing red light. All messages will be displayed until either the problem is corrected and the trouble code reset by your Correct Craft Dealer or the operator manually cancels the warning message.

Canceling System Alarms

To manually cancel system warning messages, simultaneously press both ▲ and ▼ on the tachometer.

This will disable the warning message temporarily. If the problem is not corrected in one minute (five minutes for low fuel), the warning will be displayed again. The operator can cancel as often as needed.



Section 4

NAVIGATOR

Engine Hour Meter

Displays the number of hours the engine has been operated. The display will show “XXXX.XHr.” Engine hours only accumulate when the engine is running.



Hourmeter Display

CORC126

Hours Remaining

The “time remaining” display shows the approximate number of hours the boat can operate based on the fuel remaining in the tank and the current fuel usage rate. The display will show “XXXX.XHrL.”



Hours Remaining Display

CORC127

Engine Temperature

Displays the Coolant Temperature of the Engine. There are no adjustments available.



Controls and Indicators

Voltmeter

Displays the System Voltage. There are no adjustments available.



Voltmeter Display

CORC129

Oil Pressure

Displays the current Oil Pressure. There are no adjustments available.



Oil Pressure Display

CORC130

Instrument Lights

The navigation light switch must be on for the instrument lights to function. The ▲ and ▼ on the tachometer control the instrument lighting intensity.

Press ▲ to increase the light intensity. Press ▼ to decrease the light intensity.

NAVIGATOR



Section 4

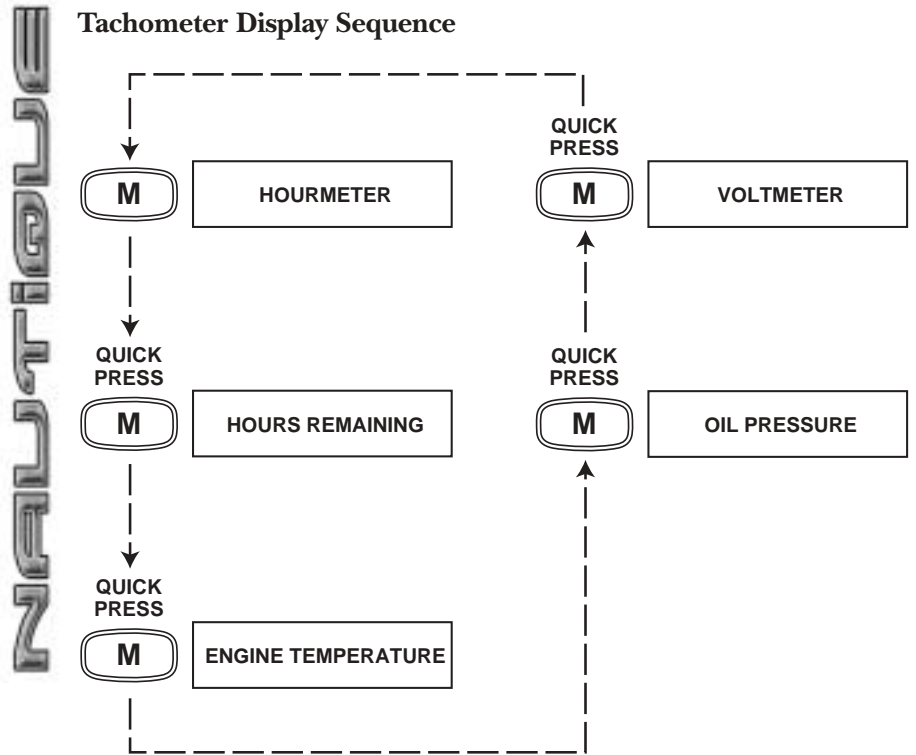

CORC131

LCD Alarm Condition Displays

Alarm messages will be displayed on the Tachometer LCD display. All messages will be displayed until either the problem is corrected or the operator manually cancels the warning message.

Messages will display as many screens shown sequentially.

Canceling System Alarms

To manually cancel system warning messages, simultaneously press both ▲ and ▼ on the tachometer. This will disable the warning message temporarily. If the problem is not corrected in one minute (five minutes for low fuel), the warning will be displayed again. The operator can cancel as often as needed.



Controls and Indicators

Severe Conditions – Includes a Flashing Red Light

Warnings

Low Battery Voltage (Flashing Red Light)



High Engine Temperature (Flashing Red Light)



Low Oil Pressure (Flashing Red Light)



Low Fuel Level (Flashing Red Light)



RPM Reduction in Progress (Flashing Red Light)



CORC132

Engine Speed Limiter Active



Knock Detection System Malfunction



Spark Delivery System Malfunction



Manifold Pressure System Malfunction



Manifold Air Temperature Sensor Malfunction



Throttle Position Sensor Malfunction



Coolant Temperature Sensor Malfunction



CORC134

Nautique



Section 4



Switches

Each electrical circuit on your boat is equipped with a control switch. The switches have an indicator light for easy ON/OFF identification. All switches are circuit breaker protected.

Refer to Standard Dash Pod in this section for additional information on switch operation.



Shower Pump (if equipped)

The shower is turned on or off by pressing and releasing the button. The indicator light for this will illuminate when the shower is on.



Heater Fan (if equipped)

The heater button controls four different heater functions.

Pressing and releasing the “heater” button turns on Low Speed.

Press again for Medium Speed.

Press again for High Speed.

Press again for Off.

The indicator light for this button will illuminate if the heater is running at any of the three speeds.



Courtesy / Docking Lights

A quick press and release of this button turns on the courtesy lights, and the indicator light for this button will illuminate. A press and slight hold turns on the indicator light and the docking lights. Both the courtesy and docking lights can be turned on at the same time, but only if the courtesy lights are turned on first.

NOTICE

If either or both of the two light functions are on, the indicator light will illuminate and a press and release will turn off any of the lights that are on.



Controls and Indicators

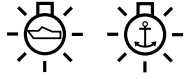

Navigation / Anchor Light

A quick press and release of this button turns on the navigation lights, and the indicator light for this button will illuminate. A press and slight hold will only turn on the anchor light and cause the indicator light to flash. A press and release of the key turns off both of the lights.



WARNING

Avoid a collision. DO NOT block the navigation lights.



Bilge Pump

The bilge pump turns on or off by pressing and releasing the button. The indicator light for this key will illuminate when the pump is on.



Engine Compartment / Bilge Area Blower

The bilge area and engine compartment blower is turned on or off by pressing and releasing the button. The indicator light for this key will illuminate when the blower is on.



WARNING

Gasoline vapors can explode resulting in injury or death. Before engine start-up, check engine compartment for gasoline vapors, then operate blower for at least four minutes. Operate blower whenever below planing speed.

Section 4

Nautique

Horn

The horn button is a momentary switch. The horn will operate whenever the button is pressed and will stop when the button is released.

Optional Dash Pod Circuit Breaker Box

All dash pod switches interface with a sealed circuit breaker box located in the driver's kickboard. The circuit breaker box consists of sixteen soft, opaque, flexible vinyl tubular shields which cover sixteen circuit breakers. When the circuits are functioning, the tubular shield is somewhat flexible. A tripped circuit breaker will extend and fill the tubular shield, causing it to be inflexible. To locate a tripped circuit breaker, run your fingers over the two rows of switches and locate the switch shield which has become inflexible. To re-set, press in the extended circuit switch shield.

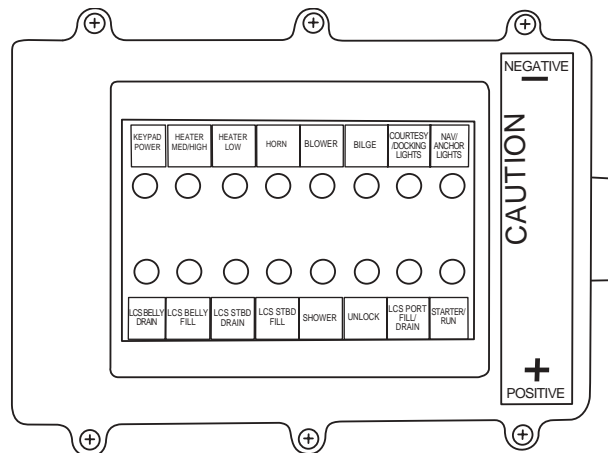

CORC035



Controls and Indicators

Standard Equipment

Tow Pylon

The tow pylon is manufactured from high strength aluminum alloy, engineered for durability. It is “hard coat anodized” and impregnated with a PTFE (teflon) material. If the pylon becomes loose, stop using the pylon and take the boat to your Correct Craft Dealer for service.



WARNING

Avoid personal injury. This water tow pylon was designed for water skiing only. Any other uses, such as parasailing, kite flying, towing other boats and/or using an extended pylon, may overstress the pylon possibly causing personal injury and/or equipment damage. DO NOT sit behind (aft) the tow pylon when towing skiers.

CAUTION

Although the extended pylon and barefoot booms have become popular additions to many tournament inboards, Correct Craft strongly objects and opposes the use of any pylon extension, whether up or to the side of any of its products. The use of pylon extensions can alter the handling characteristics of the boat, possibly resulting in dangerous instability, which could then lead to loss of control, a situation which could cause serious or fatal injury to the boat driver, passengers, skiers and anyone else who might be in the vicinity of such a mishap.

Correct Craft



Section 4

206 Nautique

CAUTION

Correct Craft does not approve of any structural changes, additions or modifications to our products. Any time a dealer or consumer makes a change to our product, they do so at their own risk and sole liability. Correct Craft, Inc. will not be held liable for unauthorized changes, whether deletions or additions, to the original equipment / product manufactured and sold by Correct Craft, Inc., even if such changes and additions are made by an "authorized" Correct Craft Dealer, customer, promotional representative or any other person, known or unknown to Correct Craft, Inc.

Bow Features of Your 206 Ski Nautique

The open bow section of your boat has removable cushions. The center section can be removed and stored in the trunk or under the love seat. Cushions on the starboard side, the port side and the front section can also be removed to access storage.

Driver's Seat Adjustment

The lever under the driver's seat on the left side allows the seat to slide fore and aft.

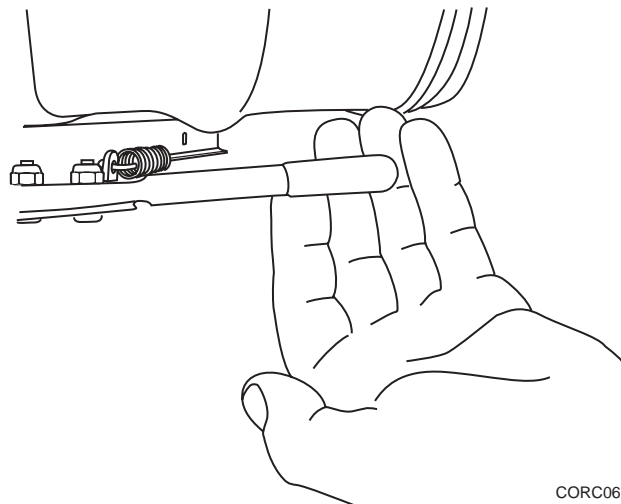

CORC069



Controls and Indicators

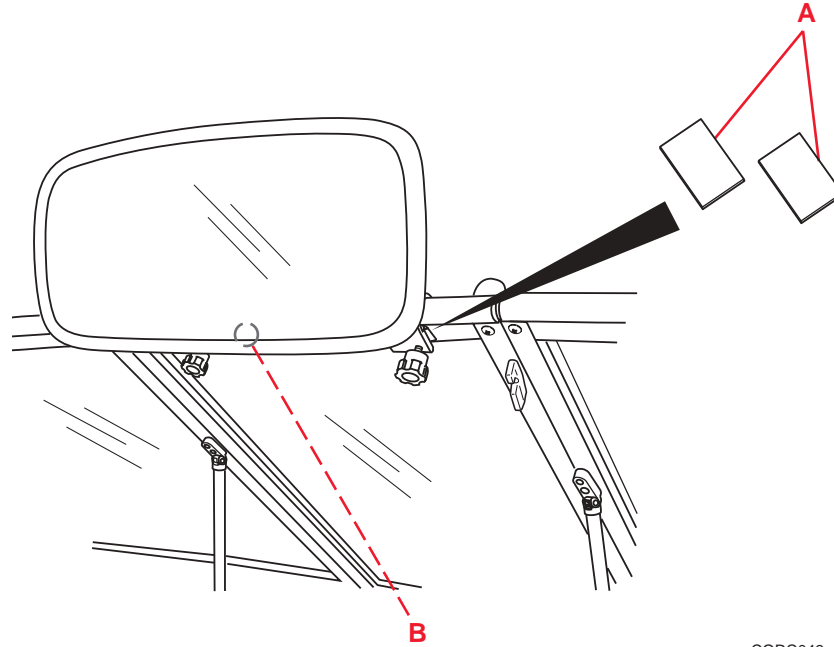

CORC043

Rearview Mirror Adjustment

The rearview mirror can be positioned on the windshield to observe a skier and traffic behind you. Use the spacers (**A**) on the inside of the windshield when securing the rearview mirror.

Use the mirror friction nut (**B**) to increase the friction of the mirror.

NAUTIQUE



Section 4

NAUTIQUE

Love Seat

Lift up on the bottom of the love seat cushion to access storage under the bow area. The entire love seat will hinge upward. You can leave the seat in the “up” position to help dry the carpet.

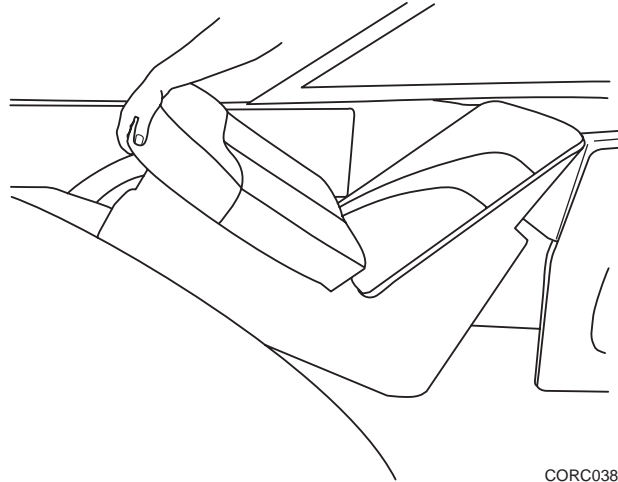

CORC038

Storage Hatch/Floor Cooler - 206 only

To open the storage hatch, lift the latch and turn counter-clockwise. The gas shock will help raise the hatch. To close and latch the hatch, pull down on the hatch and allow the hatch to close firmly. Make sure there are no hands, fingers or any other obstructions in the way of the hatch when you close it. To close the latch, turn the latch clockwise and fold the red dot down.

The storage hatch latch features a lock. Use the key to lock and unlock the latch. The key only requires about a 10° turn to lock and unlock.



Controls and Indicators

Engine Box Cover Latching/Lifting/Removal

Two rubber latches (**A**) hold the top of the engine box to the boat. Pull on the top of these latches and the upper part of the engine box will release. Lift up on the engine box handle and the gas shocks will help you lift the engine box. This "clam-shell" design allows you to check the engine without lifting the entire engine box. You can leave the top open to dry the bilge.

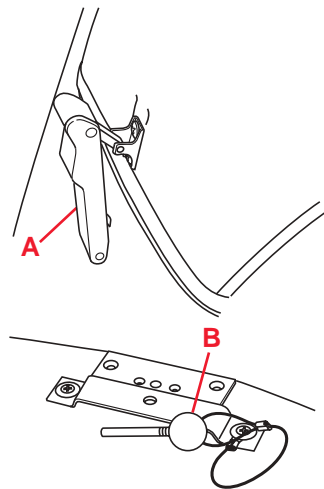

CORC040

WARNING

The engine box cover is a machinery guard. **DO NOT** operate your boat without the cover closed and in place unless you are performing a check or maintenance. **BE CAREFUL** to keep your hands, clothing, hair and any other body parts away from any moving parts. Contact with any moving parts on the engine will cause injury.

To remove the engine box cover, open the cover to expose the anchoring pins (**B**). Pull the pins out and slide the cover back. When reinstalling the cover, make sure the aft latches and pins are secured in their anchoring position.



Section 4

Nautique

Aft Seat Bottom Cushion

The aft seat bottom cushion can be removed by releasing the port and starboard rubber latches. The latches are the same used on the inside of the engine box cover. The seat cushion can then be lifted out of the boat and stored under the bow.

Walk Thru Windshield Opening/Latching (optional on 196 Ski)

There are two latches on the inside starboard side of the walk-thru windshield. Rotate both of the window locks to secure or unlock the window. Always have window closed and secured when trailering the boat.

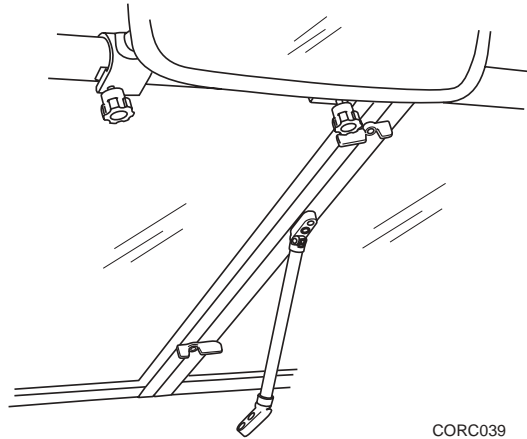

CORC039

! WARNING To avoid injury, window must be secured in the closed position when vessel is in motion. Use both window locks.

Dash and Floor Coolers

The dash and floor coolers can be used to store miscellaneous items or drinks. There is a drain installed in the coolers. Do not depend on the coolers to keep valuables or electronics dry. Keep these items in a specialized dry bag. The floor cooler has a removable tray. Do not use abrasive cleaners or place in a dishwasher. Use a mild biodegradable soap only.



Controls and Indicators

Boarding Platform

The boarding platform of your boat is a convenient feature to enhance the water sports experience. There are serious safety concerns regarding the use of the platform. Correct Craft, Inc. has placed warning labels at the driver's position, on the deck at the rear of the occupant area and on the transom. Refer to Section 1, Safety, for more information.

To remove the boarding platform, pull the two pins located in the mounting brackets and lift the platform vertically.

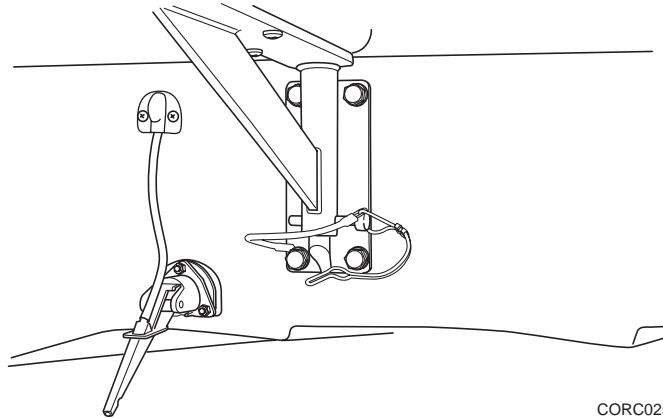

WARNING DO NOT use the boarding platform for any other purpose than boarding the boat or preparation of entering the water, and DO NOT use the boarding platform when the engine is running.

WARNING A spinning propeller or carbon monoxide can cause serious injury or death. Stay off and keep away from boarding platform while engine is running. The boarding platform must be attached when the boat is in use.

Section 4

Nautique

Engine Cooling Water Intake Valve

Your boat is equipped with a valve (seacock) on the engine cooling water intake. The handle has a slide mechanism to prevent the valve from being shut off inadvertently. The valve is used to shut off the water supply in the event a hose failure or water leakage occurs. The valve is open when the yellow handle is in-line with the valve body and the valve is closed when the handle is perpendicular to the valve body. Leave the valve open at all times unless an emergency condition requires you to close the valve to stop a leak or the possibility of a leak. The valve is located on the starboard side of the transmission.

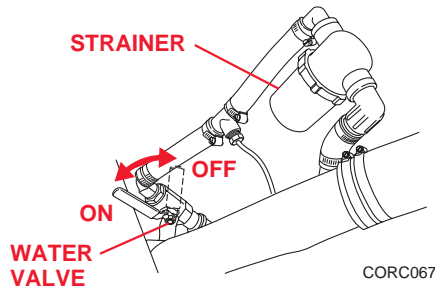

Fuel Tank

There is a fuel tank fill cap on the port and starboard side for added convenience. Use the fuel tank fill cap key to remove the fuel fill cap to fuel your boat. Use caution when fueling your boat.



WARNING

Gasoline is extremely flammable and explosive under certain conditions:

Turn the engine OFF.

DO NOT smoke or allow open flame or sparks within 50 feet (15 meters) of the refueling area.

DO NOT refuel unattended, avoid contact and spilling.

DO NOT refuel indoors.

DO NOT use a plastic funnel.

DO NOT allow any spilled fuel to remain on your boats finish.

Always maintain contact with the fuel nozzle and the fuel tank to prevent electrostatic spark.



Controls and Indicators

OPTIONAL Equipment

Stereo and Speaker Pods

All Nautiques are stereo ready. They have been pre-wired for your Correct Craft Dealer to install a stereo. Limited and Team Edition Nautiques come with a Clarion stereo with Clarion speakers or a Kicker upgrade speaker system. All of these speaker pods can be purchased as an accessory. The starboard pods are also pre-wired for the 12V receptacles. Correct Craft mounts all of its stereos in the glove box on the dash. A digital remote control can be mounted on the lower left side of the dash pod. The digital remote control displays all necessary control functions at your fingertip. Consult your Correct Craft Dealer for the stereo configuration for your boat.

Automatic Bilge Panel (Standard with optional dash pod)

Bilge Pump Only Mode - This feature is activated by a switch located on the side console. The switch has three positions, ON, OFF and BILGE. If the boat is going to sit for more than a few days with the bilge pumps on, it is important the switch is set in the BILGE position to minimize battery drain. This will activate the bilge pump and shut off power to the Serial Switching and Keyless Ignition System. It is important to remember the engine or other accessories can not be used unless the switch is in the ON position.

A circuit breaker and indicator light is located with the switch for the bilge pump. The circuit breaker is only active when the switch is in the BILGE position. The indicator light will come on anytime the bilge pump is activated.

Battery Safety Switch

The battery safety switch allows you to isolate all power to the boat, except for the automatic bilge pump. This switch provides positive disconnect of the battery to protect against tampering, electrical fire hazards and battery rundown. Rotate the switch to OFF position when the boat is not in use.



Section 4

NAUTIQUE

Board Racks

One set of four board racks will hold a maximum of four wakeboards. Do not attempt to overload board racks with more than one piece of equipment per slot. When loading boards into the rack, always insert boards into individual slots so the board bottoms are facing each other. Make sure the clamp is secure and wakeboard is not loose.

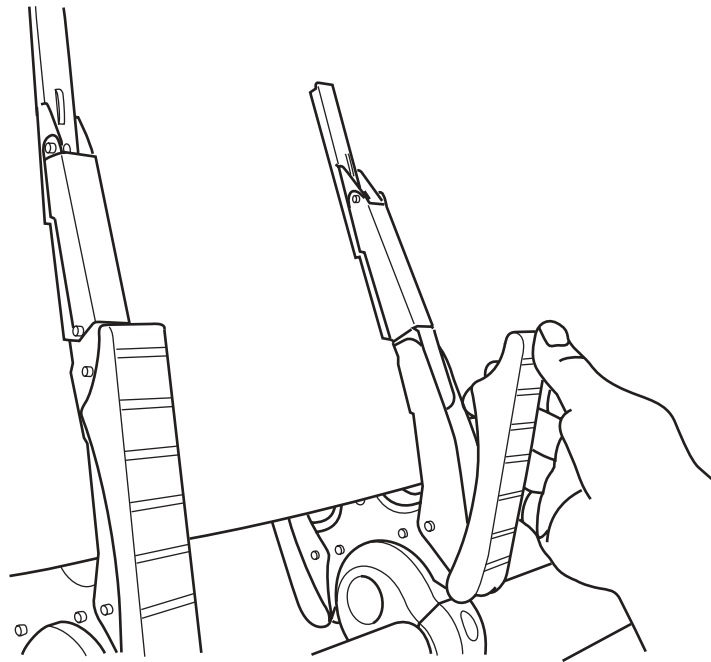

CORC059

WARNING Avoid personal injury or property damage caused by flying objects.

WARNING DO NOT trailer your boat with any items in the board racks. Personal injury or property damage can result.



Controls and Indicators

Folding Instructions for Optional Flight Control Tower

To fold the Flight Control Tower forward, loosen the knobs found under the support structure on the port and starboard sides of the tower. Fold the tower forward. The tower will rest on the grab rails of the bow section of the boat. In the folded position, strap securely to the grab rails. Reverse the steps to return the tower to the upright position. Tighten knobs securely.

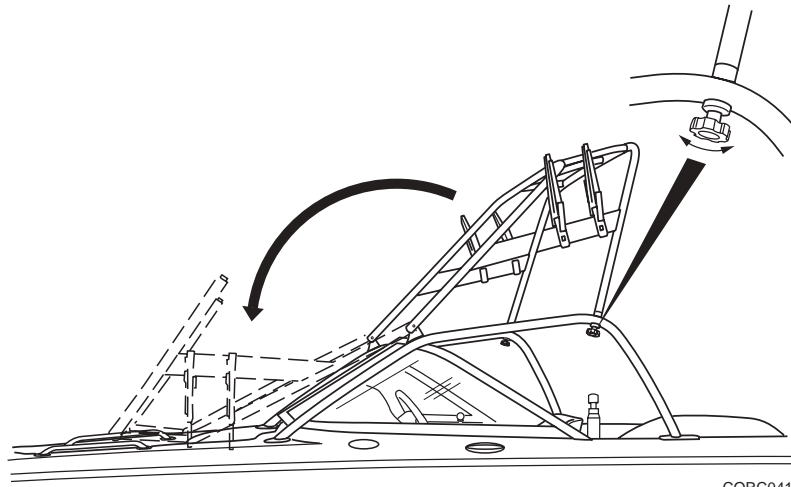

CORC041

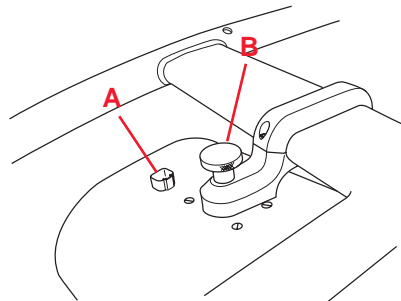

CORC052

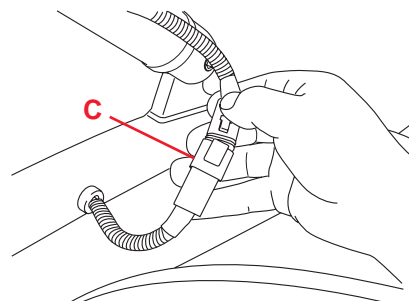

CORC065

If your tower is equipped with the optional tower speakers, they can be removed. Remove the connectors (A) and loosen the knob (B). Store the knob in the speaker enclosure. If you remove your tower for storage, remove the tower speakers and disconnect the connector (C).

Nautique



Section 4

Nautique

Rear Ballast Tank

The optional rear ballast tank is a single tank of approximately 220 pounds when full. The tank increases the wake for trick skiing, making your Ski Nautique the most versatile water sports tow package in the world.

Ballast Tank/Valve(s)

If your Nautique is equipped with the optional ballast tank, Correct Craft offers a unique fill and drain system. A standard part of this system is a ball valve that allows you to shut off flow into the tank. There is also an optional remote access valve just downstream from the ball valve that can be actuated by a lever located under the dash pod by the driver's left knee. The benefit of the optional valve is that the driver does not have to get up in order to open and close the inlet to the tank.

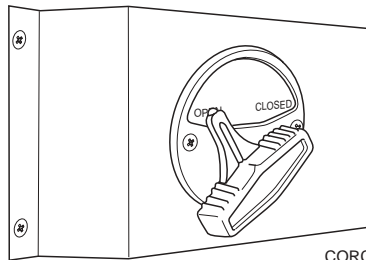

CORC063

In order to fill the tank, both of these valves must be open. Pressing and releasing the belly ballast key on the keypad turns on the fill pump. When the tank is at the desired level on the console water gauge, press and release the key again to turn the pump off. Then close the remote access valve if so equipped or close the ball valve. Pressing and holding the belly ballast key for a short time drains the tank. This will turn on the drain pump and also cause the indicator light on the keypad to blink. When the tank is empty, or at the desired level, press and release the key again to turn the pump off.

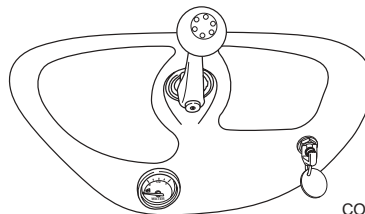

CORC062



Controls and Indicators

Optional Rudder Remote Lube - 206 Ski (standard with ballast tank)

The service allows for easy access to lubricating the rudder. The remote lube fitting is located in the stern storage area, underneath the shroud. Use a quality marine grease and gun. Connect the grease gun to the fitting and apply a light pressure to the gun until slight resistance is felt.

Optional Accessories

Optional accessories are available from your Correct Craft Dealer. Your dealer may have a wide range of other accessories available to enhance your water sports or pleasure boating experience. Contact your Correct Craft Dealer for more information. Here are just a few of the fine accessories Correct Craft offers:

- Custom Ski Rack Storage (skis not included)
- Pull-out Cleats
- Flip Up Driver's Seat

Correct Craft Cruise - Operating Instructions

Turn system ON (light blinks slowly, indicating system is activated)

Drive to desired speed, press ENGAGE and the system takes control of the throttle (light will stay on steady).

Pull back on the throttle to disengage the system (light will blink rapidly, indicating RESUME function is ready).

Accelerate again and the system resumes control at the last speed used.

RESUME key feature will recall the last speed used even if the system was shut off, completely powered down or the DISENGAGE function was used. To go back to the previous speed at any time, press RESUME.

206
CRUISE



Section 4

NEUTRAL

Press RESUME and ENGAGE together and the system will DISENGAGE, but remain activated (light will blink slowly). This feature may be used when the operator wishes to go to manual driving. To return to the last speed, press the RESUME. If the speed is to be changed, drive to that speed and press ENGAGE.

INCREASE / DECREASE key can be pressed when the system is engaged to change speed in 25 RPM increments to fine tune the speed.

User tips:

Always return to NEUTRAL and let the engine idle for two or three seconds before turning the engine OFF.

NOTICE

The servo knob cannot be moved if the engine is running.

Regularly check the set screw on the side of the black knob for tightness.

The boat speed will decrease in sharp turns. If you are towing skiers, you may wish to manually increase the throttle or use the DISENGAGE feature to maintain speed in sharp turns.

When towing wakeboarders, accelerate slightly past desired speed prior to engaging the speed control.



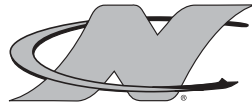

Section 5 Boat Systems

Knowing the systems, controls and indicators on your boat is essential for safe and proper operation.



WARNING

Regularly inspect and maintain all systems to prevent unexpected hazards associated with worn or faulty components. When replacement parts are required, use marine grade parts with equivalent characteristics, including type, strength and material. Using substandard parts could result in injury and product failure.

Fuel System

The fuel system consists of a built-in fuel tank, a port fuel fill, a starboard fuel fill and a fuel tank vent.

The fuel tank is located beneath the aft seat and trunk area. To inspect the hose connections, raise the floor of the trunk. Your Correct Craft dealer should perform all fuel tank service.



WARNING

Allowing a fuel system problem to go unchecked can result in a fire and/or explosion, possibly causing injury or death.

Section 5

NAUTIQUE

Fuel System

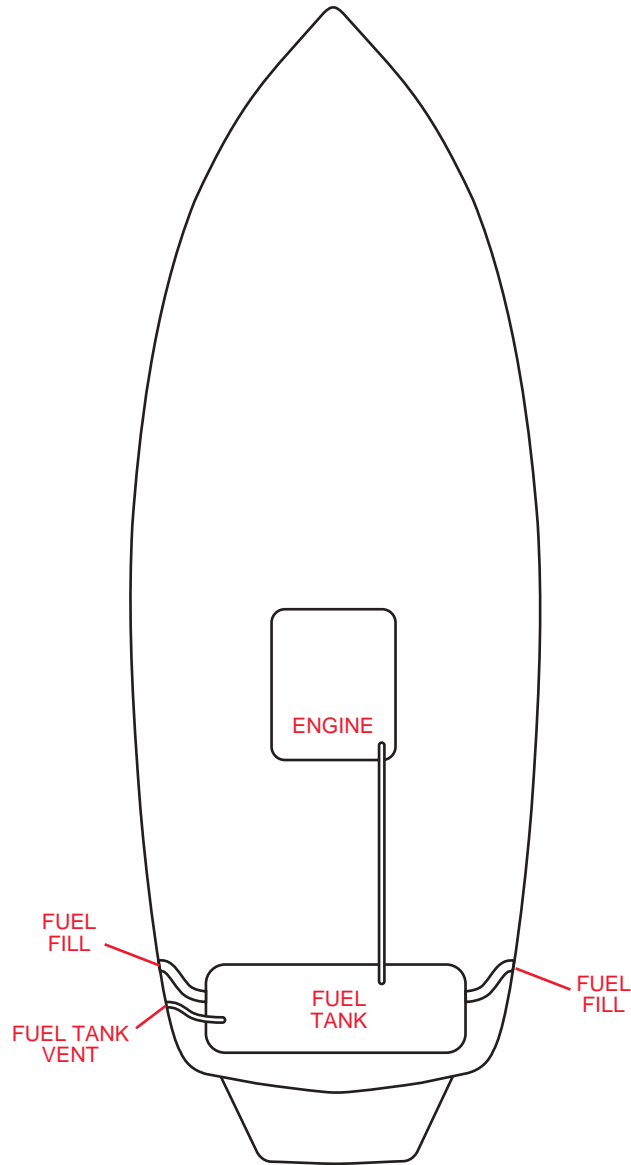

CORC096



Boat Systems

Optional Heater and Shower System

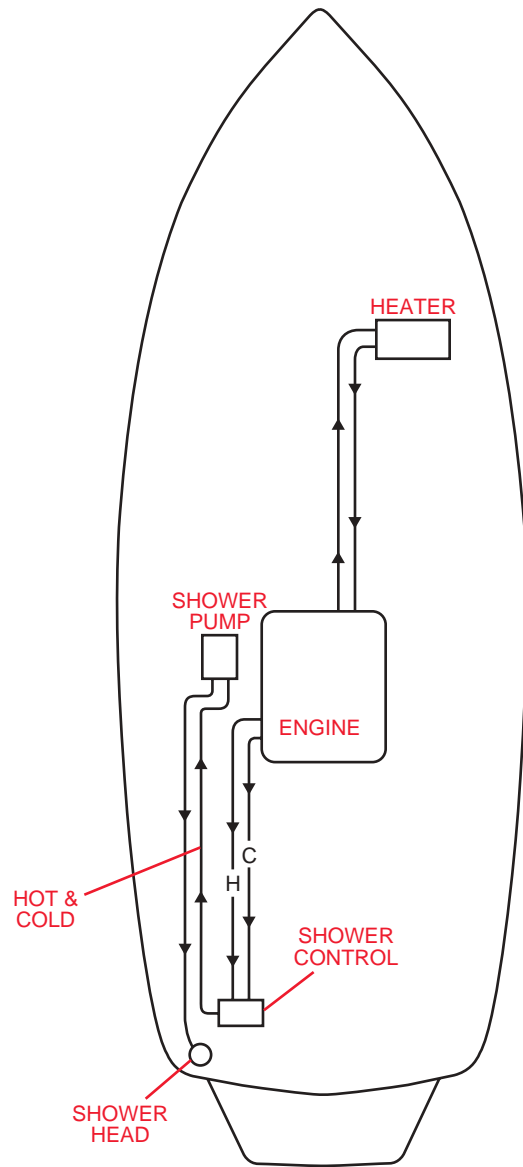

CORC098

NAUTIQUE



Section 5



Ballast Tanks and Bilge System

NOTICE

The Federal Water Pollution Control Act prohibits the discharge of oil or oily waste into the water. Violators can be fined \$5,000.00.

CAUTION

Do not allow the bilge pump to operate after all the water has been cleared from the bilge area. Damage to the pump will occur if the pump is allowed to operate without water.

WARNING

Operate the blower for at least four minutes each time you start the engine. In addition, the blower should be operated continuously when at idle and during slow speed operation. Failure to operate the blower can cause an explosion.



Boat Systems

Ballast Tank (optional) and Bilge System

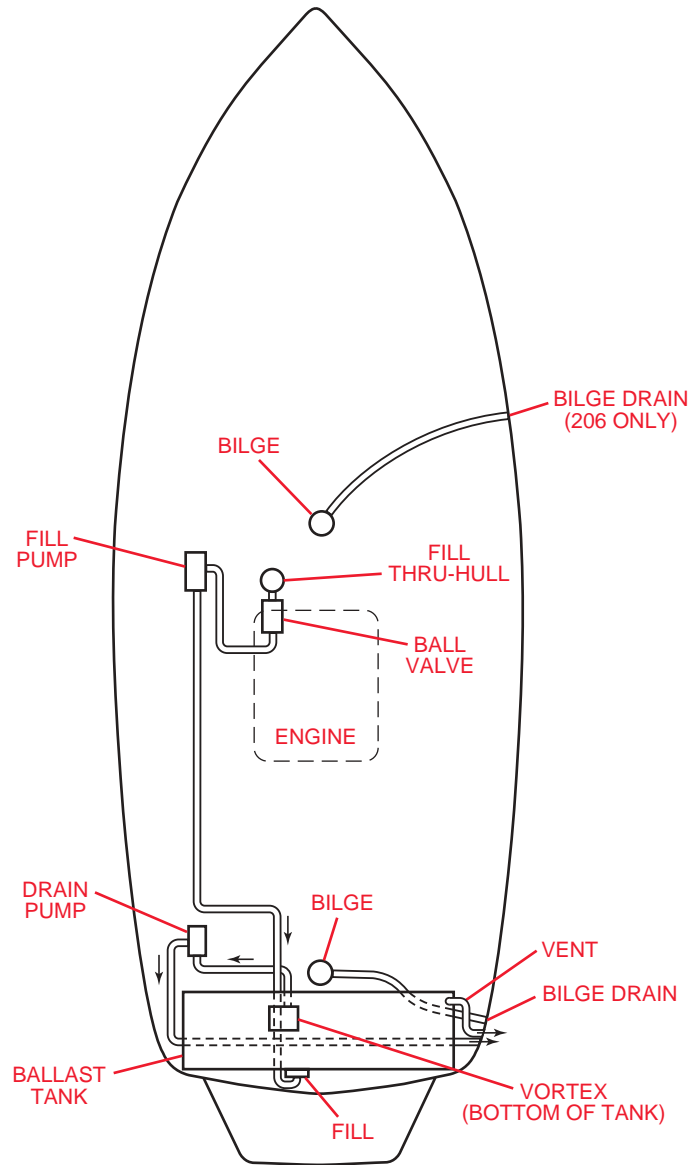

CORC100

NAUTIQUE



Section 5

NAUTIQUE





Section 6 Getting Underway

There are many things to consider to make your boating trip safe and enjoyable. You are responsible for the safety of all passengers, the boat and any damage the boat or its wake may cause. Keep passengers from blocking your view so that you do not run into other boats, swimmers, water skiers, personal water vehicles or aids to navigation.

Safety Checklist



WARNING

Do not operate the boat if any problem is found during this inspection. A problem could lead to an accident during the outing causing severe injury or death. Problems found during this inspection should be handled by your Correct Craft Dealer.

The following checks are essential to safe boating and must be performed before starting the engine.

- Check the weather report, wind and water conditions.
- Check that required safety equipment is on-board and in proper operating condition.
- Check that the fire extinguisher is fully charged.
- Be sure the boat is not overloaded.
- Be sure the operator's visibility is not obstructed.
- Check that all maintenance has been performed.
- Check the fuel system for leaks and fumes.

Section 6



! WARNING

Avoid serious injury or death from fire or explosion. A leak free fuel system is a must for safe boat use. Check your boat for fuel leaks and fumes before, during and after each use.

Safety Equipment

Federal and local laws require certain safety equipment to be on-board at all times. In addition, responsible boaters carry other equipment in case of emergency. Check with local boating authorities for any additional requirements over and above the federal requirements.

Fueling

! DANGER !

Gasoline is extremely flammable and highly explosive under certain conditions. Turn the engine OFF and do not smoke or allow open flames or sparks within 50 feet (15 meters) of the fueling area.

CAUTION

To prevent engine damage not covered by warranty, refer to your engine operation and maintenance manual for recommended fuel type and octane rating.

Take care not to spill gasoline. If gasoline is accidentally spilled, wipe up all traces of it with dry rags and immediately dispose of the rags properly ashore. Spilled fuel may yellow the gelcoat finish and damage gunwale trim.



Getting Underway

When fueling:

1. Avoid fueling at night, except under well-lighted conditions.
2. Moor your boat securely to the dock. Know the location of the fire extinguisher in case of emergency.
3. Close all doors, hatches, windows and other compartments.
4. Extinguish cigarettes, pipes, and all other flame producing items.
5. Make sure all power is OFF, and do not operate any electrical switches.
6. Add fuel in accordance with the engine operator's manual. DO NOT overfill, and allow enough room for fuel expansion.

After fueling:

1. Tighten the fuel filler cap. Wipe up any spilled fuel.
2. Check all fuel lines, hoses and connections for leaks and deterioration.

NOTICE

Each time you refuel, inspect all fuel lines, hoses and connections for leaks and deterioration.

Boarding

When boarding the boat, always step in. DO NOT jump. Avoid stepping on fiberglass or other potentially slippery surfaces. Board one person at a time.

DO NOT board the boat while carrying gear. Set the gear on the dock, board the boat and then pick up the gear.

Use the boarding platform to board from the water. To prevent injury, make sure the engine is OFF when swimmers, divers and skiers are boarding.



Section 6



Boat Planing

The performance of your Correct Craft boat depends on load weight and distribution. Distribute weight evenly, from bow to stern, and also from port to starboard.

Overloading of passengers, personal equipment and supplies could result in an accident, especially in rough waters. Maintain a balanced load at all times.

If your boat is equipped with a ballast tank or loaded, loss of horizon may occur when you begin to plane your boat. Get on plane immediately to restore the vision of your path. DO NOT operate your boat if the loss of horizon prevents you from operating it safely.

Pre-Operation Checks

! WARNING Do not operate the boat if any problem is found during this inspection. A problem could lead to an accident during the outing causing severe injury or death. Have any problem repaired by your Correct Craft.

It is the owner's responsibility to check all of the items listed below to be certain all preparation steps are completed before you use your boat. Checking these items periodically will soon become a habit. If leaks or other abnormal conditions are found, stop using the boat and contact your Correct Craft dealer to have the problem corrected.

Get into the habit of performing these checks in the same order each time so that it becomes routine.

- Make sure to check all safety items.
- Check that drain plug is properly installed.
- Check condition of propeller.
- Check that all batteries are fully charged and at the proper level.



Getting Underway

- Verify the amount of fuel in the fuel tanks.
- Be sure the lights, horn, bilge pumps and other electrical equipment are in operating condition.
- Check that steering system operates properly.
- Make sure your float plan is submitted to a responsible person.
- Refer to your engine operation and maintenance manual for additional pre-operation checks.

The following instructions are very important:

- Raise the engine hatch all the way up. Check to see if all the engine drain plugs are in place. Make sure the hull drain plug in the bilge area and also the drain plug at the transom are installed.
- Look at all the hoses to make sure they are installed and the hose clamps are tight. Close the engine hatch and turn on the engine compartment blower. Run the blower at least four minutes to remove fuel vapors that might be in the bilge area and engine compartment before starting engine. Remember, if you have detected the presence of fuel vapors, do not start the engine until the source has been determined, problems corrected and vapors removed.
- **Check all gasoline line connections.** Connections are located at the fuel tank, the fuel control cell and the fuel injection system. All Correct Craft boats are equipped with anti-siphon valves on the outlet fittings of the fuel tanks to reduce the chance of fuel siphoning from the fuel tank if a fuel hose leaks or is severed.

 **WARNING** Leaking gasoline and vapors can explode resulting in injury or death.

- Fill the fuel tank and check for leaks. Check again for leaks after the engine has run for a few minutes.



Section 6

Nautique

Before starting checklist:

1. Engine oil level - boat must be level.
2. Transmission oil level - boat must be level.
3. Shifting linkage and detent in forward, neutral and reverse.
4. Leaks (water, fuel and oil).
5. Coolant level (if the engine is freshwater cooled).
6. Operation of the throttle and transmission shift control.
7. Battery condition.
8. Visually inspect for any loose mounting fasteners.
9. Verify the emergency stop switch located by the throttle is fully functional and the lanyard is not frayed or damaged. Clip the safety lanyard securely to your body. Keep it attached at all times while you are driving.
10. Check that engine cooling water valve is open and raw water strainer is clean.

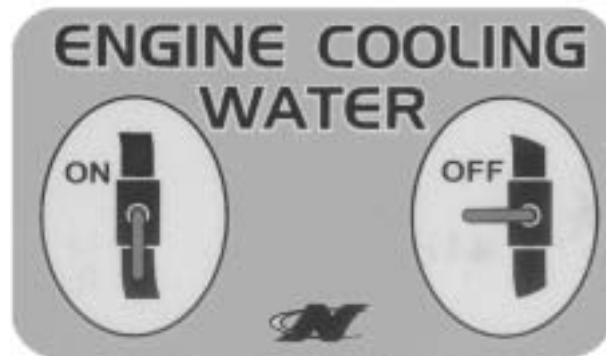

CORC015

- Once the boat is in the water, visually check for water leaking at the stuffing box. This stuffing box must drip a moderate amount of water to properly lubricate the drive shaft. If the water is coming in rapidly, pull the boat out of the water and have your Correct Craft Dealer adjust the stuffing box. There is a detailed instruction for this in the boat care section. This stuffing box has left-hand threads.

Getting Underway

- Make sure there are no ropes, gear bags, arms/legs near the belts and pulleys of the engine. Severe injury can result by becoming entangled in the belts of the engine while it is running. Make sure the boat is deep enough in the water to supply the water intake with water to cool the engine. Move the throttle into the NEUTRAL the "straight up" position.



WARNING

Before you start your engine, ventilate the engine compartment by running the blower for four minutes to remove any fuel fumes that may be in the bilge area and engine compartment, especially after repairing or refueling. Check for fuel spills or leaks before starting the engine.

- Close the engine cover.



WARNING

The engine cover is a machinery guard. DO NOT operate your boat without the cover closed and in place unless you are performing a check or maintenance. BE CAREFUL to keep your hands, clothing, hair and any other body parts away from any moving parts. Contact with any moving parts on the engine will cause injury.

- Start the engine.

CAUTION

Do not continue to operate the starter for more than 30 seconds without pausing to allow the starter motor to cool off for five minutes. This allows the battery to recover between starting attempts.

NEUTRAL



Section 6

NEUTRAL

WARNING

In order to prevent personal injury to you or others, the engine cover must be closed whenever the engine is running. **DO NOT** operate the engine with the engine cover open or while someone is in the area of an open engine cover. **DO NOT** open the engine cover unless the engine is turned OFF and rotating parts are stationary and remain in a stationary position. Rotating machinery can cause injury and even death if an accident occurs. **IT IS RECOMMENDED THAT ALL WORK ON THE ENGINE BE DONE BY TRAINED AND QUALIFIED SERVICE PERSONNEL.**

During the warm up period, check the gauges for correct and normal operation of all the systems:

- Oil pressure 35-80 psi , approximately at 2000 rpm
- Cooling water flow and water temperature 140-170°
- Cooling water temperature for fresh water systems: 170 – 210°
- Volts should rise to around 13 - 14V or higher
- Idle rpm (600 - 700) in gear

CAUTION

Do not operate at high rpms in NEUTRAL. Do not shift into forward or reverse at engine speeds above idle rpms.

CAUTION

Do not operate engine without cooling water flowing through the water pump. Water pump impeller and engine damage can result if the engine does not start. Refer to Troubleshooting in this manual.



Getting Underway

If the engine does not start:

- If the fuel filter has been changed or if the fuel system was run dry, it will be necessary to cycle the ignition start button from the STOP position to the START position several times until the fuel pumps build adequate pressure. The cycling of the ignition is necessary because the fuel pumps will run only 1-2 seconds when the ignition is turned on, unless the engine starts. Keep the shifter/throttle control in NEUTRAL when starting the engine. If the throttle is advanced, the computer will think the engine is flooded and initiate a “clear flood” condition which will shut off fuel to the engine and not allow it to start. The idle speed increase is normally on hot or cold starts. This is programmed into the computer. When the engine starts, the idle speed will jump to approximately 1,500 rpm and quickly decrease to between 750 and 900 rpm.
- Check for gasoline and cooling water leaks on the engine.
- Check for cooling water circulation (look at the water filter at the rear port side of the engine for water movement).

Flooded engine

If your engine does become flooded, use caution when attempting to start the engine. Push in the transmission disengagement button at the bottom of the shifter/throttle control handle and advance the throttle to the FULL THROTTLE position. By pushing the button in, the shift linkage is disengaged and the transmission remains in NEUTRAL during the starting procedure. Run the starter until the engine starts.

We suggest you bring your boat back to your Correct Craft Dealer after 25 hours of operation for an inspection of the shaft alignment, stuffing boxes adjustment, and the fuel system checked for leaks. This is not a free service. Follow Pleasure Craft Marine's (PCM) recommendations in the maintenance section for additional service to the engine. Consult your Correct Craft Dealer to determine what charges will apply.



Section 6

PREPARATION

When the engine starts, move the throttle lever back until the engine is running about 2,500 rpm or less. Check the gauges for normal readings and let the engine run for a minute to burn the excess fuel. If the gauge readings are abnormal, stop the engine and contact your Correct Craft Dealer. When the engine runs normally, check the engine for fuel, water and exhaust leaks. If there are leaks, stop the engine and correct them before you continue.

NOTICE

Read the "Notice to Dealer" sticker inside the engine hatch. These preparation checks have probably been completed by your dealer, but it is the owner's responsibility to check these items. This will also help you become more familiar with your boat.

After your initial run:

- Check the engine oil level
- Check the transmission oil level
- Check the V-Drive oil level (if applicable)
- Check for leaks (water, fuel and oil)
- Check that engine frame bolts and mounts are tight
- Check that throttle and shift control operates correctly

WARNING

If the engine backfires when you try to start it, the problem may be more serious than flooding. DO NOT CONTINUE TRYING TO START THE ENGINE. CONTACT YOUR CORRECT CRAFT DEALER OR A QUALIFIED TECHNICIAN TO CORRECT THE PROBLEM. DO NOT keep trying to start the engine under these conditions. Engine damage or personal injury can result.



Getting Underway

Break In Procedure

Make sure all your passengers are properly seated before starting the break in procedure. After the engine is thoroughly warmed up and you have driven the boat into a large open area, advance the throttle to wide open until the maximum rpms are reached. Do not exceed 5,000 rpm. Reduce the throttle to 2,800-3,000 rpms and cruise at or below this speed for 30 minutes. Reduce the speed to idle, advance the throttle to wide open and operate at that speed for one minute; reduce to the previous cruising speed for a few minutes and repeat. Accelerating from idle speed to wide open assists in seating the piston rings. This cycle can be repeated from time to time during the first five hours of operation. DO NOT operate engine at full throttle for longer than 1-2 minutes.

WARNING Follow these procedures only when conditions are such that you can drive the boat safely.

CAUTION Do not attempt to break in an engine by letting it idle at the dock.

Propeller Selection

The maximum rpm of the engine at full throttle under normal load conditions can be controlled by propeller pitch, diameter and design. It is essential the propeller does not underload or overload the engine.

Propeller Overloading, results in low rpms at wide open throttle will give poor performance, poor fuel economy and eventually result in engine damage.

Propeller Underloading, if operated with a propeller that has too little pitch or diameter, poor performance will result.



Section 6

NEUTRAL

NOTICE

Running your boat in shallow water can cause propeller shaft, strut, propeller and rudder damage and sand and silt to be pulled into the cooling system. This will cause excessive water pump wear and can clog the water passages in the engine. Heavy weed growth in the water can plug the raw water strainer and oil coolers and cause engine damage. There is a raw water strainer located near the rear of the engine to strainer the water before it goes into the transmission cooler and then the engine. Check this every time you use your boat to make sure it is not clogged.

Refer to **Section 1, Hazardous Conditions, Boating Safety.**

If the engine fails to start or is not operating properly, contact your Correct Craft dealer for assistance.

Shifting

WARNING Before shifting, make sure there are no swimmers or obstacles in the water near you.

Keep the control lever clean and clear of obstructions. Refer to your engine operator and maintenance manual for shifting information.

Always pause in NEUTRAL before shifting from reverse to forward and from forward to reverse.

Steering

Practice steering your boat. Make sure the steering system is working correctly and is properly maintained.

WARNING The steering system must be in good operating condition for safe boating. Frequent inspection, lubrication and adjustment by your Correct Craft dealer is recommended.



Getting Underway

Stopping

Stopping the engine immediately after operating at high speed is not recommended. Allow the engine a 2-3 minute cool-down period at idle or low speed.

Refer to your engine operator and maintenance manual for stopping information.

Docking

**DANGER**

Do not use your hands, arms or another part of your body to attempt to keep the boat from hitting the dock. The boat could push against the dock, causing severe injury.

Approach a dock slowly and use caution. Plan your maneuvers ahead of time. Allow wind and current movement to help maneuver your boat.

Come to a stop a short distance from the dock, then proceed slowly.

- Have your fenders and mooring lines ready.
- Observe how the wind and current are moving your boat. Approach the dock with the boat pointed into the wind, if possible.
- If possible, throw a line to a person on the dock and have that person secure a bow line. If no one is on the dock, maneuver as close as you can, then secure any line to a piling or dock cleat.

Before tying up your boat, be sure to use enough fenders to protect the boat from damage. If possible, tie up the bow toward the waves with a good quality double-braided nylon line. Tie up only to the lifting, tie down eyes or cleats; DO NOT use the handrails or windshield frame. If the boat is to be moored for a long period of time, use chafing protectors on the lines to protect the gelcoat finish. Leave a little slack in the lines to allow for some wave movement or tidal action is applicable.

When departing, cast off the bow line and move away. If the wind or current is pushing away from the dock, cast off all lines and allow to drift until you are clear.



Section 6

NAUTIQUE



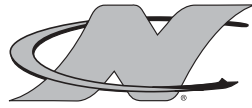

Section 7

Running

Correct Craft urges you and all others operating your boat to seek certified instruction from the local boating authorities.

This section is designed to present the most basic operational principles. It is NOT intended to cover all conditions encountered during operation. Therefore, the principles in this manual are limited to the facts related directly to the operation of your boat, while the responsibility for the proper application of these principles belongs to you.

NEUTRIQUE

Section 7

Nautique

Maneuvering Techniques

Steering response depends on three factors: rudder position, motion and throttle.

Maneuvering in congested areas and advanced courses requires mastering and good “rules of the road” ethics. Your Correct Craft boat is designed to be responsive and agile enough to meet the challenge of these conditions.

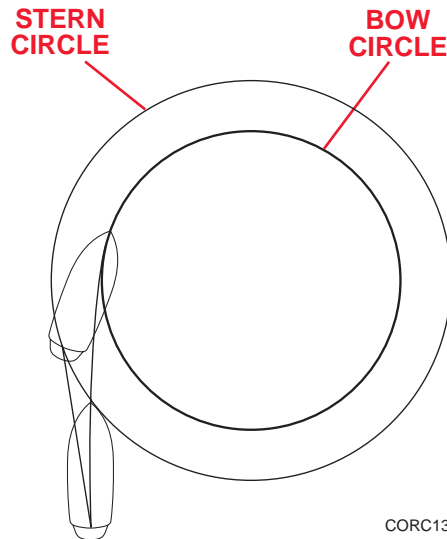

CORC135

Maneuvering

High speed maneuvering is relatively easy and takes little practice to learn. Slow speed maneuvering is far more difficult and requires time and practice to master.

When making tight maneuvers, it is important to understand the effects of turning. Since both thrust and steering are at the stern of the boat, the stern will push away from the direction of the turn. The bow follows a smaller turning circle than the stern.



WARNING

Quick maneuvers when you or your passengers are not prepared could cause people and objects in the boat to be thrown about possibly resulting in injury or death. DO NOT make quick or high-speed maneuvers when you or your passengers are not prepared.



Running

The effects of unequal propeller thrust, wind and current must also be kept in mind. While wind and current may not always be present, experienced boaters will use them to their advantage. Unequal thrust is an aspect shared by all single engine propeller-driven watercraft. A clockwise rotation propeller tends to cause the boat, steering in the straight ahead position, to drift to starboard when going forward, and to port when going backward. At high speed, this effect is usually unnoticed, but at slow speed, especially during backing, it can be powerful. For this reason, many veteran boaters approach the dock with the port side of the boat toward the dock, if possible.

Stopping (checking headway) is a technique that must be developed. Reverse thrust is used to slow and stop the boat. The momentum of the boat will vary according to the load as well as the speed. Make it a practice to slow to idle (no-wake) speed before shifting into reverse.

It is best to learn maneuvering skills in open water away from traffic. Adequate practice is the only way to develop your boating skills.

Tow Pattern

A large loop pattern is preferred for beginners. This pattern does not require the skier to cross the wake. As the skier's skills improve, a looped end or dumb bell pattern may be used. The dumb bell pattern provides a long straight course which allows the wake to disperse, leaving the skier with a smooth water surface. The dumb bell pattern is popular with ski tournaments and clinics.

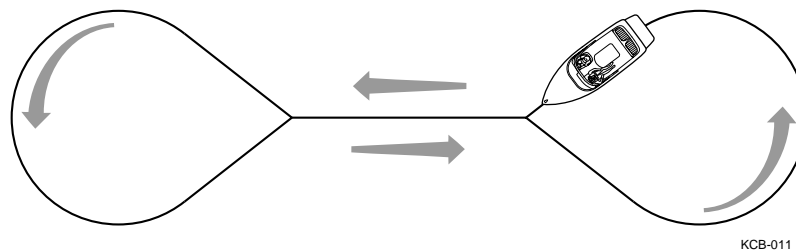

Dumb Bell Ski Pattern

Ski



7-3

Nautique

Section 7

NAUTIQUE

Freezing Temperatures

When the boat is removed from the water, drain the cooling system shower and heater system (as equipped) completely.

Anchoring

There are many types of anchors available on the market. The choice of one anchor over another depends on many factors. An anchor will usually hold best in a mixture of mud and clay or in hard sand. A Danforth anchor is recommended for general boating. For more information on anchors, contact your Correct Craft dealer.

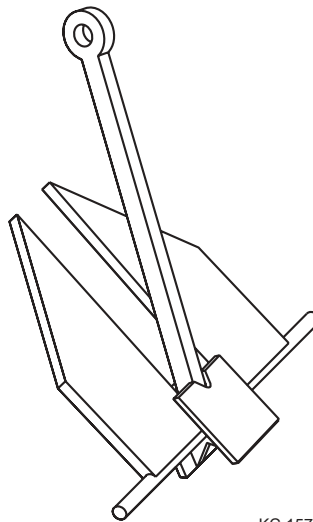

KC-1571C

Danforth Anchor

WARNING

Anchor from the bow, not from the stern.
A strong current can pull a boat, anchored by the stern, underwater and keep it there.



Running

Dropping Anchor

- Make sure the line is tied to the anchor and tie the other end to the forward cleat or bow eye.
- Head the boat into the wind or current over the spot where you want to lower the anchor. Spot the boat before lowering the anchor.
- When the anchor hits bottom, slowly back up the boat, keeping tension on the line. Let out an anchor line that is 6 to 7 times the depth of the water. For example, if you are in 10 feet (3 m) of water, let out 60 to 70 feet (18 to 21 meters) of line.

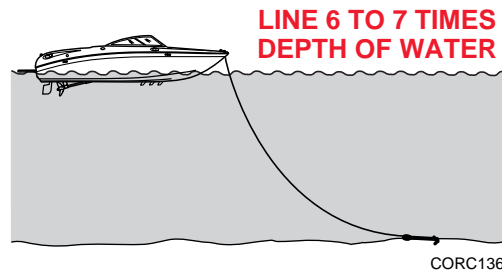

Anchoring

- Pull on the line to make sure the anchor is holding.
- Occasionally check your position against the shoreline. If the anchor is dragging and you are drifting, reset the anchor.

Weighing (Pulling In) Anchor

Start the engine and move forward until the anchor line is straight up and down. Pull hard to lift the anchor from the bottom material.

If the anchor is caught on the bottom, attach a line to the bow cleat so that it is taut. The up and down motion of the bow from wave action may lift the anchor from the bottom. If the anchor remains caught, let out a few more feet of line and attach it to the bow cleat. Slowly maneuver the boat around the anchor until the anchor pulls loose. Be sure to keep the line tight during this procedure.



Section 7

PERFORMANCE

Performance Boating

! WARNING Keep one hand on the steering wheel and the other on the control lever at all times. If the boat begins to operate in an unsafe way, pull back on the control lever. Failure to maintain control could result in severe injury or death.

Your Correct Craft boat is a high performance boat. DO NOT be tempted to push your boat to its limits until you are completely familiar with its operating characteristics.

Nautiques are the boat of choice of the better professional and amateur ski shows and tournaments. You may have seen drivers put their Nautique through extreme maneuvers. These drivers are paid professionals on a closed course with hundreds of hours of experience. Do not attempt extreme maneuvers without proper training.

We recommend that you never operate the boat without first having an initial orientation and familiarization/demonstration ride with your dealer or an operator experienced with the boat/engine combination. All boats perform differently.

The operator should have at least ten hours of experience with the boat before any full throttle operation. Do not operate your boat until you are completely experienced with its handling characteristics.

Propellers

Your Correct Craft boat is equipped with a propeller best matched to its engine and boat combination. If you feel you are experiencing poor performance, contact your Correct Craft dealer. Care and selection of your propeller is very important to proper boat operation.





Section 8 Care and Maintenance

This section describes how to care and maintain your Correct Craft boat. Periodic inspection and maintenance of items listed in this section is absolutely necessary.

Winterization and some engine maintenance functions are best performed by your Correct Craft dealer. Some maintenance items that can be done by you or your dealer are listed below. We suggest that you familiarize yourself with these even if you have your dealer service your boat.

General Maintenance

1. Read engine operator and maintenance manual very carefully.
2. Check for fuel line leaks every time you use the boat.
3. **DO NOT** start your engine if gasoline odor is present. Gasoline fumes are highly explosive. Before starting your engine, open the engine cover, inspect the engine compartment for gasoline fumes and operate the blower for at least four minutes. Run your blower when operating at slow speeds. If fuel vapors are present, do not start the engine. Check all hoses and fittings to determine the source of the vapor. Make the necessary adjustments or take the boat to your local dealer to eliminate the fuel vapor.



WARNING

Prior to starting the engine, you must open the engine cover and check the engine compartment and bilge for gasoline and oil vapors. You must also operate the blower for at least four minutes. Failure to do so may result in fire or explosion. If you smell gasoline vapor or see liquid gasoline, DO NOT start the engine.

Section 8

OPERATION

4. When servicing the ignition switch or any wiring, always disconnect the battery cables from the battery.
5. Check for water circulation when the engine is running. Exhaust should contain steady flow of water. In closed cooling systems, make sure the coolant in the cooling system is at the proper level.

Engine Intake Water Strainer

Visually inspect the engine intake water strainer for debris before each use. To clean the strainer, close the engine intake water valve and unscrew the strainer bowl (A). DO NOT lose the rubber O-ring (B) that seals the bowl to the cap. Carefully remove the screen (C).

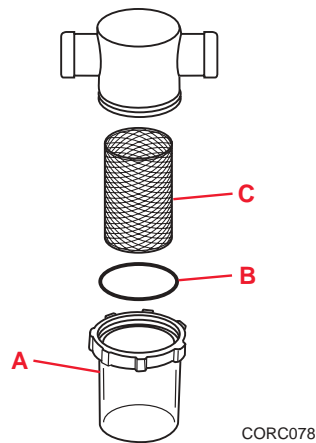
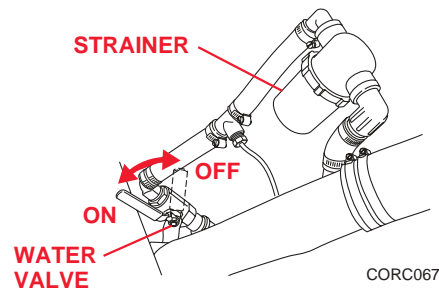

Care and Maintenance

Clean debris from the bowl and screen and rinse parts in fresh water. Insert the screen, place the O-ring in the groove of the bowl, and screw the bowl on hand tight. Be sure to open the water valve before starting the engine.

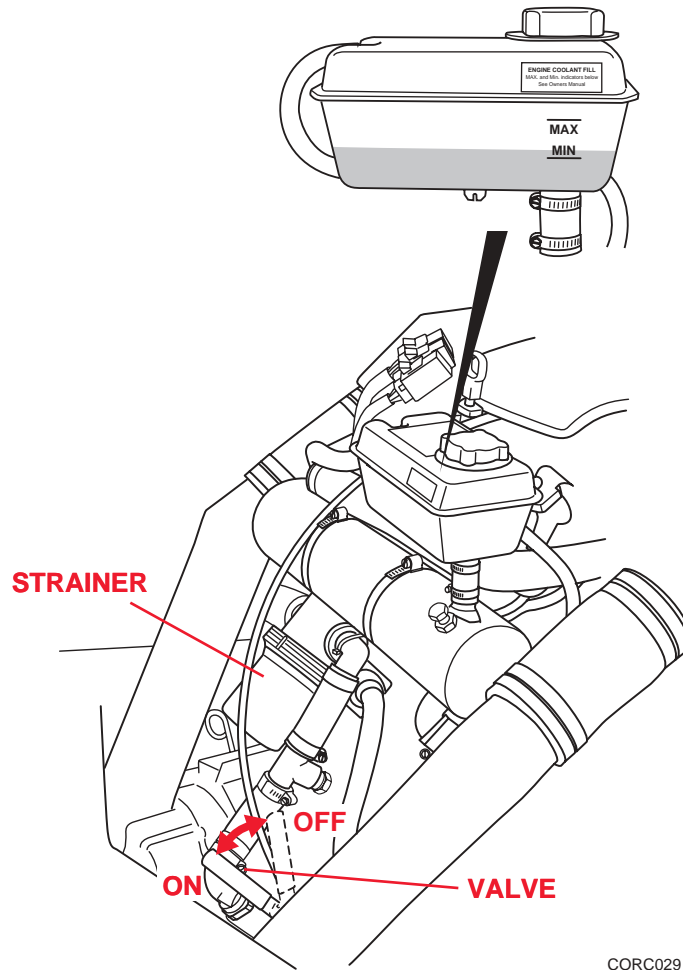

Some engines are equipped with a closed cooling system with a self-contained reservoir for engine coolant. Self-contained systems are equipped with a heat exchanger which uses raw water to cool the coolant. All raw water systems are equipped with a valve and strainer.



Section 8



Bilge Pumps

Check your bilge pumps often to make sure they are operating efficiently. There are two bilge pumps: one is at the rear of the boat near the rudder and under the floor by the forward bulkhead located next to the fuel tank. Keep the pumps from getting clogged, remove any debris you find in the bilge. Wash the bilge with a good biodegradable household detergent or a bilge cleaner available at your Correct Craft dealer or a marine supply store. Rinse with water with your bilge pumps running. If your pumps seems to lag, remove the top of the pump from the base and check the impeller to make sure there is no debris inside. See your dealer if there is still a problem with the pumps.

Propeller

CAUTION

- A propeller can be very sharp. Be careful when you handle it. Wear a pair of protective gloves when handling any propeller.
- Remove your key from the ignition and remove the Emergency Stop Switch clip from the switch to prevent accidental starting of the engine.
- Do not reuse the nylon locknut or the cotter pin.
- Do not use a damaged propeller. A damaged propeller can damage your engine and boat.

Removal

1. Remove the cotter pin from the propeller shaft and discard.
2. Wedge a piece of 1" x 4" wood between the propeller blade and the starboard side of the strut and rudder.
3. Remove the nylon locknut and discard.



Care and Maintenance

Remove propeller and key from the keyway. Inspect the keyways and key for any damage.

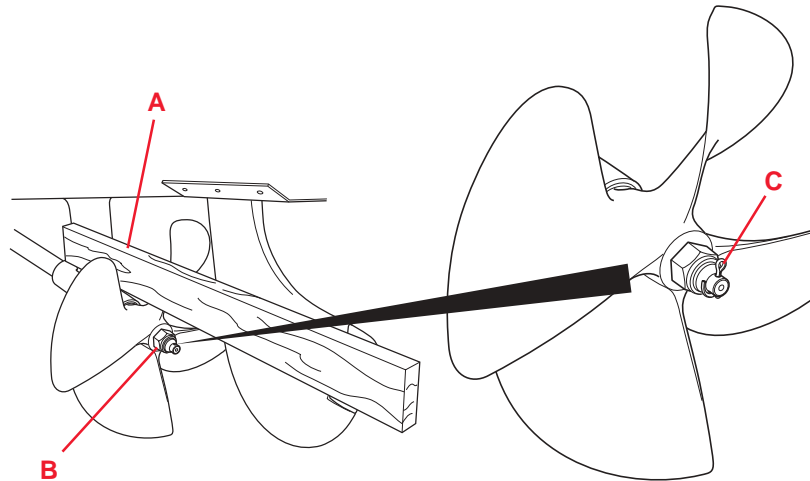

CORC047

Installation

Before placing the propeller on the shaft, look at the keyway on the shaft and in the propeller. Make sure the key slides freely in the shaft keyway and the propeller keyway.

If the key has burrs, remove them filing the flat sides or replace the key. **DO NOT** file the key beyond its normal shape or size.

1. Rotate the shaft until the keyway is “up.”
2. Place the key in the shaft keyway. The propeller will only slip on in one direction. Rotate the propeller so the keyway in the propeller is aligned with the keyway on the shaft. Once it is aligned, push the propeller onto the shaft. You’ll hear a solid “thunk” or feel it, as the propeller is seated.
3. Wedge a piece of 1" x 4" wood (**A**) between the propeller blade and the port side of the strut and rudder.
4. Install a new nylon locknut (**B**) and torque the nut to maximum of 30 ft lbs (40.7 N•m).
5. Install new cotter pin (**C**). Bend the retaining ends of the cotter pin in the opposite directions. Make sure the cotter pin is snug and does not rotate.



Section 8

MAINTENANCE

Propeller Shaft Stuffing Box

The stuffing box is designed to prevent water from coming through the through-hull fittings. These are found on the propeller shaft where the shaft goes through the hull and where the rudder comes up through the bottom of the boat. These devices contain a lubricated fibrous packing that acts as a seal.

Check the propeller shaft stuffing box frequently for excessive leakage. The engine must be off. A leaking rate of a few drops per minute is acceptable and expected for proper lubrication. Raise the engine cover and remove the storage bulkheads. If you see a steady stream of water or an excessive drip rate, return your boat to your Correct Craft dealer for service.

Non V-Drive Models

1. You will need two pipe wrenches, 12" of .032 gauge stainless steel safety wire, flat blade screwdriver and wire cutters. Remove the engine cover. Remove the floorboard between the engine cover and the stern seat.

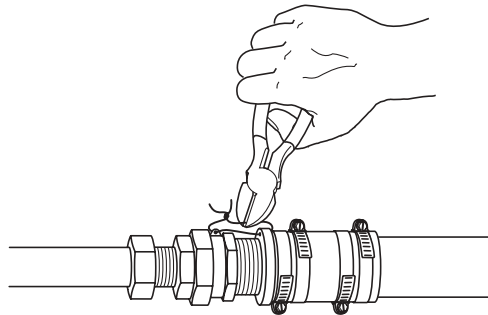

CORC107



Care and Maintenance

2. Cut and discard the safety wire. (The wire prevents the packing gland nut from loosening.)
3. Hold the gland nut (large nut) with a pipe wrench and loosen the locking nut with another pipe wrench.

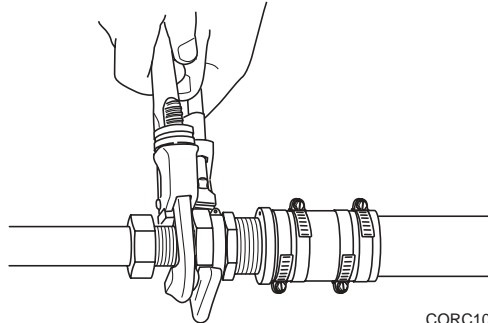

CORC108

4. **HAND-TIGHTEN** the gland nut until the dripping slows down to about 6-10 drips per minute.

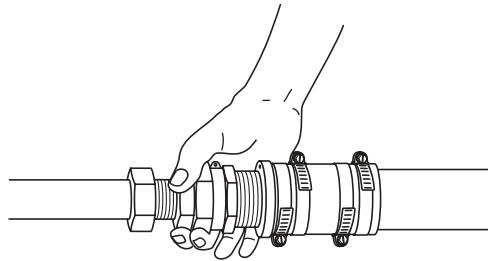

CORC109

5. Using wrenches as in step 3, retighten the locking nut against the gland nut. Make sure it is **VERY TIGHT**. If you still experience leakage, consult your Correct Craft dealer.
6. Loosen one of the hose clamps at the rear of the assembly. Rotate the assembly until the safety wire eyelet is on top, and retighten the hose clamps.

NEALPORTER



Section 8

MAINTENANCE

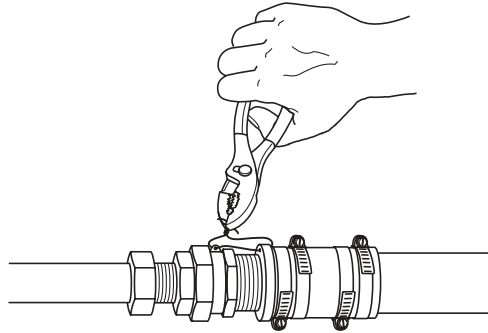

CORC110

7. Replace the safety wire.

NOTICE

Replace the safety wire. It is very important. Use a stainless steel safety wire of at least .032 gauge.

Through-Hull Fittings

All fittings that actually pass through the hull on the wetted surface are caulked in. These are not serviceable and must not be tampered with.



Care and Maintenance

Quick Oil Drain System

Change the engine oil after the first 25 hours of operation, then after every 50 hours. The boat must be removed from the water to use the quick oil drain system. There is a drain hose attached to the bottom of the oil pan with a small plug screwed into the loose end of the hose. Remove the drain plug at the transom and put the end of the drain hose through the drain hole.

Make sure there are no kinks or sharp bends in the hose. Remove the plug at the end of the hose and drain the oil into a container under the boat. The engine will drain most efficiently when the oil is warm. Allow several minutes for the oil to settle and drain. Dispose of used oil in an environmentally safe manner.

NOTICE

Be sure the engine is off when you are draining your oil.



WARNING

Used engine oil can be harmful. Avoid prolong or repeated contact with skin. Wash affected area immediately with soap and water.

Salt Water Boating

NOTICE

If you use your boat in salt water or other unusual water conditions, fresh water flush your engine and cooling system with freshwater.

Correct Craft offers an optional fresh water flush kit. The relief valve in this kit prevents excessive water pressure to your engine. We recommend using this system if you use your boat in salt water or unusual water conditions. Flushing the system by running the boat in fresh water is another good way to flush the engine, but it must be done immediately.



Section 8

MAINTENANCE

Battery Maintenance

⚠ WARNING The battery cables should be removed from the battery when the boat is placed in storage, on display, or in transit. This will eliminate the possibility of the engine accidentally starting without a supply of cooling water and may damage the engine.

Wear eye protection and rubber gloves when working on or around batteries.

- DO NOT charge or use a battery booster to start your engine. Always charge the battery outside of the boat. The vented fumes can lead to an explosion or fire.
- Take care when connecting or disconnecting a battery charger. Be sure the charger is turned off and unplugged from power source when you clip on/off the connecting clamps. Make sure you have a solid connection with the charging clamps. Poor connections are common causes of electrical arcs which can cause an explosion. Follow the instructions.
- Use a voltmeter or hydrometer to check the battery charge condition.
- DO NOT smoke or bring a flame near a battery at any time.
- DO NOT have your head directly above a battery when making or breaking electrical connections.
- DO NOT use a metal object to spark between battery posts to check if the battery is charged.
- DO NOT make or break electrical circuits at the battery terminals; a spark will occur when a live circuit is opened or made.



Care and Maintenance

To clean your battery, remove and wash down the battery case with a diluted ammonia or baking soda/water solution to neutralize the acid, then flush with fresh water. Keep the fill/vent caps tight so the neutralizing solution does not get into the battery cells.

The electrolyte level should be checked every 30 days. Add only distilled water to maintain the level between the top of the plates and the bottom of the fill/vent cap. DO NOT overfill. Remember batteries contain sulfuric acid which can cause severe burns.

Gelcoat Maintenance

Your Skipper's Kit included samples of quality boat care products recommended by Correct Craft. Correct Craft is proud of its heritage and wants you to feel this pride every time you use your boat.

Regular maintenance is the key to keeping your hull and deck surfaces in good condition. Sun exposure, residue from trees and minerals in the water affect your boat's finish.

To help maintain the shine of your boat, wash the hull with a mild bio-degradable detergent after each use. This will help to remove any debris and waterborne materials that are on the hull. Use a soft sponge or towel and dry with a chamois cloth to prevent water spots.

Wax the hull sides and deck regularly with a high quality wax. Waxes and polishes are available at your Correct Craft dealer and marine supply stores. Always follow the directions on these products carefully before you use them.

The hull bottom is an especially important area to keep clean since any buildup of water scum and algae will create drag and reduce the boat's efficiency. If you must leave your boat in the water, there are compounds to remove algae buildup on your hull. Some of these can be caustic. Pay special attention to the cautions on the label of these coatings. Ask your Correct Craft dealer for advice on which work best in your area.

Correct Craft



Section 8

MAINTENANCE

If your boat's gelcoat develops a chalky look over a period of time due to exposure to sun, there are gelcoat buffing and polishing compounds available at your Correct Craft dealer and marine supply stores. **DO NOT** use common household scouring pads or powders.

If you will be keeping your boat in the water for ANY period of time, we suggest that the wetted surface of the hull be painted with an epoxy paint formulated for blister protection.

Teak Care

Teak is a unique wood used for marine applications. It is an open cell wood that is highly resistant to the dry-rot associated with many other woods and is also highly resistant to marine organisms. **DO NOT** coat the teak on your boat with any kind of varnish or polyurethane coatings. Teak oils and cleaners are available at marine supply stores.

When the teak on your boat is new, it has a medium brown color. After a period of time, exposure to the elements will cause it to turn a weathered gray color. If you want to refinish the teak, we suggest you purchase a teak cleaner from a reputable marine supply store. Follow the instructions on the teak refinishing bottles. You should use these products in an open space with eye protection, rubber gloves and good ventilation. Be very careful to avoid spilling these products on any part of your body or boat.

NOTICE

*Teak sealers and cleaners can be harmful to other materials. Make sure you thoroughly remove any spills or excess. **DO NOT** varnish teak as the natural oils in teak will cause poor adhesion.*



WARNING

DO NOT store rags used to clean or treat teak on your boat. Store or dispose rags properly ashore.



Care and Maintenance

Care of Metal

Keep all metal work rinsed and wiped dry. Periodically polish it with a quality commercially available metal polish to remove substances such as air-borne pollution and natural body oils from your hands.

Care of Glass

Your windshield, mirrors and gauge faces all deserve the same attention as the other parts of your boat. Clean them often with quality commercially available glass cleaners.

Vinyl Maintenance and Cleaning

Correct Craft has selected the finest marine grade vinyl for your Nautique. It is important to keep it clean at all times. There are some substances that will stain the vinyl if you leave them on for even a short period of time. Remove any contaminant and clean the area immediately. **DO NOT** use Formula 409® Cleaner or any silicone based products. Certain household cleaners, powdered abrasives, steel wool, industrial cleaners, dry cleaning fluids and lacquer solvents can cause damage and discoloration. **DO NOT** use these cleaners.

**2
3
4
5
6
7
8
9
10
11
12
13
14
15
16
17
18
19
20
21
22
23
24
25
26
27
28
29
30
31
32
33
34
35
36
37
38
39
40
41
42
43
44
45
46
47
48
49
50**



Section 8



Common stains and steps to treat:

	Step #1	Step #2	Step #3
Chewing gum	D	A	D then A
Eye shadow	E	B	E then B
Engine oil	B	B	B
Spray paint	C	B	B
Mildew or wet leaves *	D	B	A
Shoe polish *	A	B	
Yellow mustard	D	B	
Oil based paint (fresh)	D	B	
Oil based paint (dried)	A	B	
Suntan lotion *	D	B	
Tar/Asphalt	A	B	
Lipstick	A	B	
Latex paint	A	B	
Crayon	D	B	
Ketchup	A	B	
Grease	D	B	
Ball-point ink *	E	B	
Permanent marker *	E	B	
Coffee, tea, chocolate	B	B	

Use the chart above to clean common stains:

- A. Medium-soft brush, warm soapy water/rinse/dry
- B. Meguires Quick Clean #52
- C. One(1) tablespoon ammonia, (1/4) cup hydrogen peroxide, 3/4 cup water rinse/dry
- D. Wipe or scrape off excess (chill gum with ice)
- E. Denatured Alcohol/rinse/dry

After all cleaning methods, rinse well with water.

*Suntan lotion, shoe polish, wet leaves and some other products contain dyes that stain permanently.



Care and Maintenance

Tunable Rudder*

The Tunable Rudder is designed to offer easy steering adjustment. This system uses a composite tuning foil which is located at the upper aft corner of the rudder blade. Use a Phillips head screwdriver to adjust the foil. Loosen the two screws in the relief slots of the tuning foil.

If the boat is pulling port, rotate the foil to port (A) and tighten screws. If the boat is pulling starboard, rotate the foil to starboard (B) and tighten screws. Always remember that movement of the trailing edge of the foil to one side will cause the steering to pull to the opposite side.

NOTICE

After each adjustment, test run and adjust again if necessary.

*Manufactured under license from National Products, Inc. U.S. patent 5,746,147.

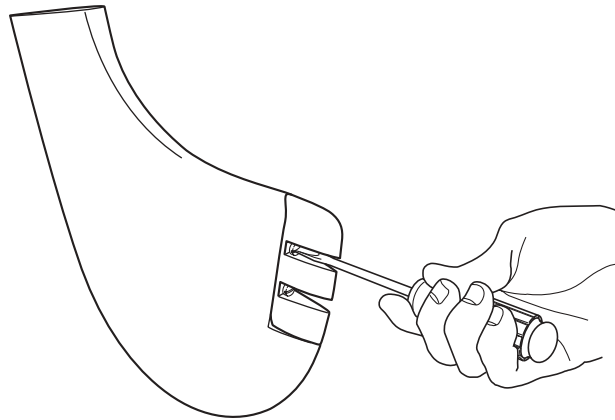

CORC045

NAUTIQUE



Section 8

NAUTIQUE

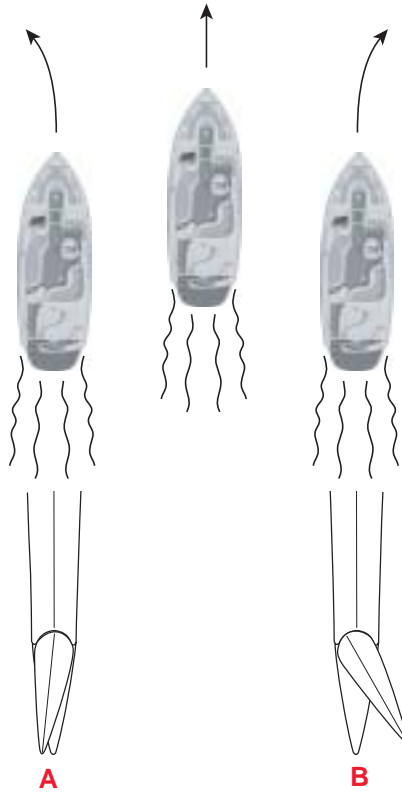

CORC044

Rudder Remote Lube Fitting (if equipped)

The remote lube fitting allows for easy access to lubricating the rudder. The remote lube fitting is located in the stern storage area, underneath the shroud. Use a quality marine grease and gun. Connect the grease gun to the fitting and apply a light pressure to the gun until you feel a slight resistance.



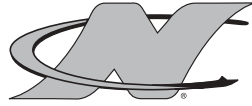

Section 9 Troubleshooting

The following chart will assist you in finding and correcting minor problems with your Correct Craft boat. Refer to your engine operation and maintenance manual for more detailed information for any problem concerning the starting, shifting or operation of the engine.

Some problems may require the skills of a trained technician and special service tools. Please contact your Correct Craft dealer for assistance.

Correct Craft

Section 9

NEUTRIQUE

Trouble Check Chart

Performance

Symptom	Possible Cause
Starter motor will not operate	• Shift handle not in NEUTRAL
	• Battery safety switch OFF
	• Battery and electrical connection loose or corroded
Engine will not start	• Emergency stop switch not in place
	• Starting procedure not followed
	• Fuel tank empty
Poor boat performance	• Contaminated fuel
	• Clogged fuel filter
	• Uneven load distribution
	• Improper propeller selection
	• Marine growth on hull
Poor gas mileage	• Engine problem
	• Marine growth on hull
Excessive vibration	• Damaged or fouled propeller
	• Misaligned propeller shaft coupling
	• Bent propeller shaft
	• Engine problem
Engine runs but boat makes little or no progress	• Fouled or damaged propeller
	• Engine problem
Steering problem	• Corroded steering cable
	• Rudder worn
Throttle/shifting problems	• Corroded cables
	• Defective throttle return spring
	• Low transmission fluid level
	• Sticking transmission shift lever



Troubleshooting

Electrical

Symptom	Possible Cause
Electrical problem	• Open circuit breaker or blown fuse
	• Loose wiring connection
	• Defective switch or gauge
Dim or no lights	• Open circuit breaker tripped or in OFF position
	• Battery discharged

TRU
S
E
R
I
E
S



Section 9

NAUTIQUE





Section 10 Storage

Lifting Rings

Your boat has lifting rings at the bow and at the stern. These are designed to lift your boat in a steady and secure manner. Use a winch with a lifting capacity sufficient for your boat. Refer to **Section 3** Specifications. The weights listed in the specifications are dry weight. You must add the weight of the battery, fuel and gear to the dry weight.

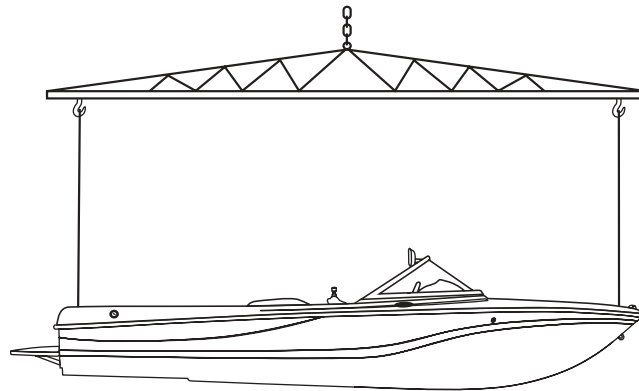

CORC138

CAUTION

Drain the bilge and/or launch control system and/or aftermarket water bladder(s) to eliminate excess water before you lift the boat.

NOTICE

Only use a hook that will pass easily through the lifting ring without binding. A hook that is too large or off-center could break the lifting ring. DO NOT use a sling or any other means to lift the boat. Damage to your boat can occur.

Section 10

WINTERIZING

Winterizing Your Boat

Winter storage procedures vary depending on climate, type of storage and length of storage. Check with your dealer/storage facility manager for their advice on what works best in your climate.

When storing your boat up on a rack system, it is important the racks adequately support the hull bottom.

If you don't have a trailer, support the boat like a Correct Craft recommended trailer. It is important to have an even weight distribution.

If you do not have a dealer or marina nearby and must arrange winter storage yourself, contact your regional warehouse.

If you use a mooring cover, DO NOT put it on when the interior of the boat is wet and/or hot. It will trap moisture and lead to mildew on the carpet and/or vinyl. Make sure your mooring cover allows air to circulate, even if you have to leave a portion of the cover off.

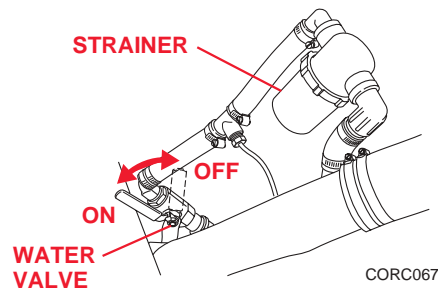

Storage

The sea strainer bowl (A) remains full of water even after the rest of the engine cooling water system is drained. To properly winterize your boat, the strainer must be removed and emptied. **DO NOT lose the rubber O-ring (B) that seals the bowl to the cap.** Clean screen (C) if required. If the water is not removed, the bowl can be damaged. A damaged sea strainer can cause overheating problems during the next season.

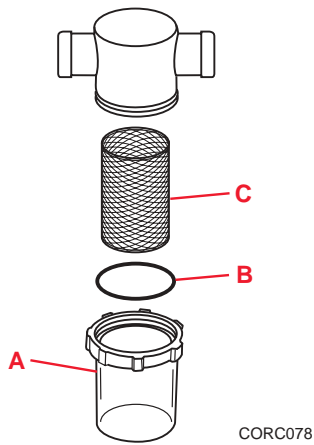

NAUTIQUE



Section 10

Check For Water In Your Fuel System

A small amount of water left in the fuel system for several months can result in damage to the fuel system and engine. If you are storing your boat for the winter, it is a good practice to remove any water in the fuel system.

The Fuel Control Cell can be drained by removing the drain plug at the bottom of the canister.

1. Loosen the incoming fuel hose to provide an incoming air source.
2. Clamp the incoming fuel line some way to minimize the amount of fuel that may drain.
3. Once the canister is drained, coat the threads of the drain plug with a fuel resistant pipe thread sealer, then replace and tighten the plug.
4. Reconnect the fuel hose, and tighten the hose clamp. The threads must be sealed properly to avoid a possible fuel leak.

Check your Fuel Control Cell once each year for signs of water in the canister. If it appears there is water buildup in the canister, see your Correct Craft dealer for service.

An empty fuel tank can accumulate water inside by changing temperature and repeated cycles of condensation on the inner surfaces of the tank. If the fuel tank is kept at about 3/4 full during storage, less water can condense, limiting the buildup of water in the fuel tank.

Fill the tank to 3/4 full maximum during storage to eliminate the possibility of fuel expansion caused by temperature changes. This minimizes overflow of fuel from the fuel vent. Not only can this overflow be hazardous, but it will also adversely affect decals and pin striping on the boat.



Storage

Allow room in the tank for fuel expansion caused by temperature differences. Add a good quality fuel stabilizer to the fuel prior to winterizing to slow down the rate of fuel decomposition. You can purchase a fuel stabilizer at your servicing dealer, most marinas or an auto supply store. Add the stabilizer to the tank and then fill the tank to approximately 3/4 full.

If you did not add the stabilizer previously, run the engine to circulate fuel throughout the system. Remember, always follow the fuel stabilizer manufacturer's recommendations for proper mixing.

NOTICE

Gasoline expands when the temperature increases. Never store your boat with more than 3/4 of a tank.

Refer to the engine's owner's manual for winterization of the engine.

Winterizing Optional Rear Ballast Tanks

Winterize the rear ballast tanks by doing the following:

1. Make sure the tank(s) system seacocks, located in the bilge, are open. Empty the system completely using the drain pumps.
2. Remove the stern seat base, engine cover box and removable floor section from the boat. Each tank has a drain hose located adjacent to the muffler on the appropriate stringer. Remove the cap from the drain hose and allow the tank to drain until it stops. Reach under the fuel tank and remove the empty hoses from the empty pumps. Remove the fill hoses from the fill pumps under the front of the engine. Raise and lower the bow of the boat while the system is draining to ensure the water is removed from the pumps.
3. Re-install all hoses, put the caps back on the drain hoses and re-assemble the boat.



Section 10



Trailer/Trailer

Hitch

If you don't already have a trailer hitch installed on your vehicle, go to a reputable installer to have the proper size hitch installed. Always use a hitch rated with the appropriate capacity to match the trailer and boat's gross weight.

WARNING

DO NOT attempt to tow more than one trailer at a time behind your vehicle. Attempting to tow an additional trailer will adversely affect the trailer tongue weight and loss of vehicle control and/or injury or death may occur.

CAUTION

DO NOT use a bumper mounted hitch on your vehicle. Use a hitch that is attached to the frame of your vehicle only. DO NOT compromise your equipment, your safety or the safety of others.

Wiring

The trailer requires wiring from your vehicle to the trailer lights. This can usually be done by the hitch company.

Security

There are several locking devices available at marine supply stores to aid in securing your boat whether or not it is attached to your vehicle.



Storage

Towing Your Boat

Read this checklist prior to trailering your boat.

- Check wheel lug nuts for tightness.
- Be sure the trailer tongue is securely on the hitch and the safety chains from the trailer are secured to the vehicle.
- Be sure a cable or strap secures the bow eye of the boat to the trailer. Make sure this is tightly secured.
- Be sure the trailer electrical connector is plugged in. Allow sufficient slack for cornering. Check brake lights, turn signals, emergency flasher and running lights.
- Be sure your gear inside the boat and seat cushions cannot shift or fly out of the boat during trailering.
- Be sure the walk-thru door of the windshield is closed and latched while the boat is being trailered.
- If you are using any sort of water "ballast" system to add weight to the boat, be sure it is drained before you put the boat on the trailer. These systems can adversely affect the tongue weight of the trailer. Your boat is not designed to carry exceptionally heavy loads. This can adversely effect the proper balance of the boat/trailer combination and cause tire failure and/or loss of control.
- If your boat is equipped with a bow winch, make sure the boat is properly located on the trailer and the winch strap/cable is tight.
- Make sure the platform bracket pins are in place before trailering.

NAUTIQUE



Section 10

PREPARATION

Long Trips

DO NOT use your boat and trailer to haul excessive gear.

Each time you stop on a long trip, check the following:

- Make sure the wheel lug nuts are tight and the bearings are lubricated.
- Make sure the boat is still positioned snugly against the bow stops.
- Examine the hitch connection to be sure it is firmly attached and the safety pin and chains are securely fastened.
- Make sure all trailer lights are still functioning properly.
- Re-examine the contents of your boat to ensure that no items such as life jackets or other gear have shifted and will not fly out while you are on the road.





Glossary

ABYC – American Boat and Yacht Council, Inc.

AFLOAT – On the water.

AFT – Toward the rear or stern of the boat.

AGROUND – Touching bottom.

AMIDSHIP – Center or middle of the boat.

b – (1) An iron casting shaped to grip the lake bottom to hold the boat. (2) The act of setting the anchor.

ANODE – An electrode carrying a positive charge

ASHORE – On the shore.

ASTERN – Toward the stern.

BAIL – To remove water from the bottom of the boat with a pump, bucket, sponge, etc.

BALLAST – Any solid or liquid weight placed in a boat to increase the draft, to change the trim.

BEAM – The widest point on the boat.

BEARING – Relative position or direction of an object from the boat.

BILGE – The lowest interior section of the boat hull.

BOARDING – To enter the boat.

BOUNDARY WATERS – A body of water between two areas of jurisdiction; i.e., a river between two states.

BOW – The forward end of the boat

BULKHEAD – Vertical partition (wall) in a boat.

BUNKS – Carpeted trailer hull supports.

BURDENED BOAT – Term for the boat that must "give-way" to boats with the right-of-way.

CAPACITY PLATE – A plate that provides maximum weight capacity and engine horsepower rating information. It is located in full view of the helm.

CAPSIZING – To turn over.

Ski

N
A
U
T
I
Q
U
E

G-1



CAST-OFF – To unfasten mooring lines in preparation for departure.

CATHODE – An electrode carrying a negative charge

CAVITATION – A phenomenon in which low pressure within a liquid allows vapor bubbles to form

CENTER LINE – A lengthwise imaginary line which runs fore and aft with the boat's keel.

CHINE – The point on a boat where the side intersects (meets) the bottom.

CLEAT – A deck fitting with ears to which lines are fastened.

CONSOLE – Also called helm. The steering wheel area of the boat.

CRANKING BATTERY – The main battery used for engine starting and electrical circuits.

CURRENT – Water moving in a horizontal direction.

DEADRISE – Transverse angle of the bottom of the hull.

DECK – The open surface on the boat where the passengers walk.

DRAFT – The depth of the boat below the water line, measured vertically to the lowest part of the hull.

ELECTROLYSIS – The break-up of metals due to the effects of galvanic corrosion.

FENDER – Devices built into or hung over the sides of a boat to prevent the boat from rubbing or chafing against other boats or piers.

FORE – Toward the front or bow of the boat. Opposite of aft.

FREEBOARD – The distance from the waterline to the upper surface of the side of the deck.

FUEL SENDING UNIT – The electrical device that is mounted on the outside of a built-in fuel tank and controls the dashboard fuel gauge.

GIVE-WAY BOAT – (1) Term for the boat that must take whatever action necessary to keep well clear of the boat with the right-of-way in meeting or crossing situations. (2) The burdened boat.

GUNWALE – The rail or upper edge of a boat's side.

HEAD – A marine toilet.

HELM – The steering wheel or command area.

HULL – The structural body of a boat below the deck.



Glossary

HYPOTHERMIA – A physical condition where the body loses heat faster than it can produce it.

IN-LINE FUSE – A type of protective fuse located in the power wire of a direct current (DC) circuit usually near the battery.

KEEL – The lowest portion of the boat; extends fore and aft along the boat's bottom.

LINE – All rope in a boat or on the dock is referred to as "line."

LIST – Leaning or tilt of a boat toward the side.

MAKING WAY – Making progress through the water.

MARINE CHART – Seagoing maps showing depths, buoys, navigation aids, etc.

MID SHIP (AMIDSHIP) – In the vicinity of the mid-length of a boat, technically the exact half way between the bow and the stern.

MOORING – An anchor, chain, or similar device that holds a boat in one location.

NAVIGATION AID – Recognizable objects on land or sea such as buoys, towers or lights which are used to fix position to identify safe and unsafe waters.

NMMA – National Marine Manufacturer's Association

NO-WAKE SPEED – The speed at which a boat travels to produce an imperceptible wake.

PFD – Personal flotation device.

PITOT TUBE – See SPEEDOMETER PICKUP TUBE.

PLANING HULL – A hull designed to lift, thereby reducing friction and increasing efficiency.

PORPOISE – A condition in which the bow bounces up and down caused by trimming the engine too far out.

PORT – (1) The left side of a boat when facing the bow. (2) A destination or harbor.

PRIVILEGED BOAT – Term used for the boat with the right-of-way.

PROPELLER PITCH – Theoretical linear distance the propeller would move ahead during one complete revolution of it were turning with zero slippage.

RIGHT-OF-WAY – Term for the boat that has priority in meeting or crossing situations. The stand on or privileged boat.

RUB RAIL – The rubber extrusion that is fastened over the hull and deck joint.



N

RUDDER – A vertical metal device used to steer the boat

RULES OF THE ROAD – Regulations for preventing collisions on the water.

SACRIFICIAL ANODE – Metal parts fitted to the hull of boat to provide a transfer of ions to the cathodic part of an electrolytic coupling and so protect other parts of the boat that would otherwise waste away through electrolysis

SLIP – The linear distance between the pitch (or advance) and the actual distance the propeller moves straight ahead through the water.

SPEEDOMETER PICKUP TUBE – Also called pitot tube. The plastic device that extends below the bottom of the boat. It connects to the speedometer with plastic flexible tubing.

SPRING LINE – A mooring rope oriented at a small angle to the boat's centerline, usually attached to the boat mid ship.

STAND ON BOAT – Term for the boat that must maintain course and speed in meeting or crossing situations. The privileged boat.

STARBOARD – The right side of the boat when looking towards the bow.

STERN – The aft end of a boat.

STOW – To put away. To store cargo in a storage locker.

STRINGER – Members under the floor that stiffen the hull bottom.

SURGE BRAKES – A type of trailer braking system designed to automatically actuate when the tow vehicle's brakes are applied.

TRANSDUCER – The unit that sends/receives signals for the depth sounder.

TRANSOM – The transverse beam across the stern.

TRIM – Fore to aft and side to side balance of the boat when loaded.

UNDERWAY – Boat in motion; i.e., not moored or anchored.

USCG – United States Coast Guard

VISUAL DISTRESS SIGNAL – A device used to signal the need for assistance such as flags, lights and flares.

WAKE – The waves that a boat leaves behind when moving through the water.

WATERLINE – The line of the water's edge when the boat is afloat.

WATERWAY – A navigable body of water.

WETTED SURFACE – The area of the immersed hull plus underwater gear.





Warranty

CORRECT CRAFT LIMITED WARRANTY

(Boat as Originally Manufactured by Correct Craft)

The Correct Craft, Inc. warranty is backed by a family tradition of boat building experience since 1925

Lifetime Limited Warranty

Correct Craft, Inc. warrants to the original purchaser of each new Correct Craft boat that under normal authorized use, the deck, hull and stringer system, as originally manufactured by Correct Craft, shall remain free from structural defect in material and workmanship for as long as the boat is owned by the original purchaser.

Transferable Lifetime Limited Warranty

In addition, Correct Craft offers a Transferable Lifetime Limited Warranty covering the deck, hull and stringer system as detailed in the Lifetime Limited Warranty above. This policy may be transferred (for a nominal fee) to the second (2nd) purchaser during a period of five (5) years from the date of delivery to the original purchaser. See your local dealer for details.

Exception: The "Lifetime" and "Transferable" warranties do not cover the gelcoat, nor any other components fastened or applied to the hull or deck. Gelcoat discoloration, blisters, or bubbles and cracks are not considered structural defects.

WARRANTY

WARRANTY

Five (5) Year Limited Warranty, Transferable

Correct Craft, Inc. warrants to the original purchaser that each new Correct Craft boat, as originally manufactured by Correct Craft, shall under normal authorized use be free of defect in material and workmanship for a period of five (5) years from the date of delivery to the original purchaser. This coverage applies to factory-installed steering assembly, electrical components, fuel tank system, hardware and trim, interior vinyl, v-drive, and options. This policy may be transferred (for a nominal fee) to the second (2nd) purchaser during a period of five (5) years from the date of delivery to the original purchaser. See your local dealer for details.

ENGINE Three (3) Year Transferable Limited Warranty –

For details see Pleasurecraft Marine Engine Co. owner's manual

Miscellaneous Parts Limited Warranty – Correct Craft, Inc.

warrants to the original purchaser that the following items shall under normal authorized use be free of defect in material and workmanship from the date of delivery to the original owner for: Two (2) years – Stereo; One (1) year – gel coat, upholstery stitching, boarding platform, and windshield.

Exceptions: This "Correct Craft Limited Warranty" shall not apply to...

- Any Correct Craft boat which has been used at any time for commercial or racing purposes, as a demonstrator or in a promotional program, ski school or ski show.
- Normal maintenance and wear items, or any component thereof, including but not limited to alignment, adjustments, connectors, tune-up and parts, saltwater/brackish water corrosion, non-skid material, battery, bushings, packing material, belts, bulbs, hoses, filters, seals, gaskets, o-rings, water pump impellers.
- Gelcoat finish or colorfastness of gelcoat finish, chrome plated, anodized or aluminum finish or colorfastness of finish.



Warranty

- Damage or malfunction of a boat, or any component thereof, resulting from owner use, lack of maintenance, improper maintenance, impact, misuse, negligence, collision, delay of repair (unless specifically and directly authorized by the Correct Craft warranty department in writing), trailer or trailer design, improper or inadequate trailering or cradling of the boat.
- Any addition, modification or repair of the boat, or any component thereof, caused by, resulting from or in connection with any party other than Correct Craft, Inc., or any defect or product failure caused by, resulting from or in connection with any such addition, modification or repair.
- **Any and all consequential damages including, but not limited to, costs incurred for haul-out, launching, towing, and storage charges, telephone or rental charges of any type, inconveniences, or loss of time or income.**

Any defect or damage covered by this warranty shall, at the discretion of Correct Craft, Inc., be repaired free of charge at an authorized dealership or service facility. Repairs will be warranted only for the remainder of the original warranty period. Transportation and/or labor to and from the point of repair will be the responsibility of the owner.

THERE ARE NO WARRANTIES WHICH EXTEND BEYOND THE DESCRIPTION OF THE FACE HEREOF. THIS LIMITED WARRANTY IS EXPRESSLY MADE IN LIEU OF ALL OTHER EXPRESSED WARRANTIES. DURATION OF ANY IMPLIED WARRANTY OF MERCHANTABILITY OR FITNESS FOR A PARTICULAR PURPOSE OR OTHERWISE, SHALL BE LIMITED TO AND COINCIDENT TO THE DURATION OF THESE EXPRESSED WARRANTIES. UNDER NO CIRCUMSTANCES SHALL CORRECT CRAFT, INC. BE LIABLE TO THE PURCHASER OR ANY THIRD PARTY FOR LOSS OF PROFITS OR OTHER DIRECT OR INDIRECT COSTS, LOSSES OR CONSEQUENTIAL DAMAGES ARISING OUT OF OR AS A RESULT OF DEFECTS IN PRODUCTS HEREIN ABOVE WARRANTED.

Ski



W-3

CORRECT CRAFT



Some states do not allow limitations on how long an implied warranty lasts. Some states do not allow the exclusion or limitation of incidental or consequential damages. This warranty gives you specific legal rights, and you also have other rights which may vary from state to state. To the extent that your state does not allow any exclusion or limitation expressed herein, such exclusion or limitation will not apply to you. All other allowable limitations or exclusions shall apply to you.

Note: This warranty is expressly conditioned upon the completion and return of the warranty registration card to Correct Craft, Inc. Although not obligated to and without creating such an obligation, this will enable us to notify you of any necessary performance or safety modifications to your boat and to verify ownership in case a warranty claim is filed on your boat.

Procedure:

In the event your Correct Craft boat has a claim covered by this warranty, the following procedure shall be allowed to secure performance of warranty obligations:

1. **Notify the selling dealer in writing within thirty (30) days after the discovery of any claimed defect.**
2. You may be required to transport the boat, at your expense, to an authorized dealership or service facility for their inspection and/or repair.
3. Correct Craft, Inc. reserves the right to require further evaluation and/or information regarding a warranty claim against a boat prior to its repair as well as designate the place of repair.

Correct Craft, Inc. reserves the right to make changes in prices, color, specifications, equipment, options, materials, hull, decks, and/or discontinue models at any time (without notice), and shall be under no obligation to equip or modify boats built prior to such changes.

Correct Craft, Inc. 6100 South Orange Avenue, Orlando, Florida 32809. 407/855-4141, FAX 407/851-7844, E-mail address: ski@correctcraft.com. Effective 2004 Model boats.



Warranty

Request for Warranty Transfer

Correct Craft's Lifetime Limited Warranty against structural defects in the hull, deck and stringer of model 2004 boats can be transferred, for a nominal fee, to the second purchaser within five (5) years from the date of sale to the first purchaser. The sale must be complete within the first five years. The limited warranty will be transferred upon the receipt and verification of: (1) this completed form, (2) a COPY OF THE ORIGINAL PURCHASE RECEIPT, (3) a payment of \$300.00 to "Correct Craft, Inc." This data MUST BE RECEIVED WITHIN 15 DAYS OF THE SALE DATE. The warranty will be transferred retroactive to the sale date. Review the warranty policy for details.

NOTICE

THIS TRANSFER DOES NOT INCLUDE THE ENGINE.

Original Owner Name: _____

Boat Model / Type: _____

Hull Number: CTC... _____

New owner information:

Name _____

Street / P.O. Box _____

City / State / ZIP Code _____

Date purchased _____ Phone # _____

The criteria listed above must be received within 15 days of the sale date. Submit it to Correct Craft, Inc. 6100 South Orange Avenue, Orlando Fl 32809 Attention: Warranty Department.

NOTICE

Upon verification, the warranty will transfer retroactive to the sale date.

Ski



W-5

Correct Craft



Nautique Friend Program

It has been proven that experience and word-of-mouth are important promotional tools. Enthusiastic boat owners talk to their friends. Our statistics reveal that a high percentage of our Nautique owners learned about Correct Craft through a friend. We want to show our appreciation to these friends.

One year after the purchase date listed on an owner's warranty card, we send a "NEW OWNER SATISFACTION SURVEY." For the completion and return of this form, we offer a first anniversary gift of a Nautique Gear T-shirt. It is our desire to keep in touch with our Correct Craft family of boat owners. We value our owners' comments and want to hear about the things we do right and/or the things we need to improve. One of the questions asked is, "How did you learn of Correct Craft?" This section adds a statement, "If a friend influenced you, please list his/her name and address." From this information, the President of Correct Craft sends that "Friend" a letter of thanks and a Nautique Gear hat.

When a "Friend" appears on our list the second time, indicating success in encouraging another person to purchase a Nautique, this person receives a personal thank you letter from the President of Correct Craft with a certificate to return with the appropriate size indicated, and receive a Correct Craft T-shirt.

When a "Friend's" name is presented for the third time, this person will receive a personal letter from the President of Correct Craft with a certificate for a Correct Craft polo shirt.

For the fourth and succeeding times a "Friend" is listed, a personal letter will be mailed as well as a certificate for \$50 retail value of Nautique Gear item(s).

Tell the story of your experiences with your boat, your dealer, and Correct Craft. When you are responsible for convincing a non-Correct Craft owner to buy a Nautique, encourage that new owner to give you credit for that introduction on his first anniversary survey form.



Warranty

If you find that the information contained in this owner's manual does not answer your specific question, then we invite you to contact your nearest dealer or your Nautique Service Center for answers or necessary service. A list of the Nautique Service Centers is given on the following pages, with the areas that they service.

NAUTIQUE





NAUTIQUE SERVICE CENTERS

Mid Atlantic Correct Craft

**Route 30, Box 188
Speculator, NY 12164
518/548-9763**

Connecticut
Delaware
District of Columbia
Maine
Maryland
Massachusetts
New Hampshire
New Jersey
New York
Pennsylvania (Eastern)
Rhode Island
Vermont
Virginia

Midwest Correct Craft

**P.O. Box 216
Angola, IN 46703
260/833-2226**

Illinois
Indiana
Iowa
Kansas
Kentucky
Michigan
Minnesota
Missouri
Nebraska
North Dakota
Ohio
Pennsylvania (Western)
South Dakota
West Virginia
Wisconsin



Warranty

Southwest Correct Craft
22450 FM RD 1995
Lindale, TX 75771
903/882-8593
Arkansas
Louisiana
Oklahoma
Texas

Southeast Correct Craft
7576 South Orange Ave.
Orlando, FL 32809
407/851-1965
Alabama
Florida
Georgia
Mississippi
North Carolina
South Carolina
Tennessee

West Coast Correct Craft
11340 White Rock Rd., Suite A.
Rancho Cordova, CA 95742
916/638-3382
Alaska
Arizona
California
Colorado
Hawaii
Idaho
Montana
Nevada
New Mexico
Oregon
Utah
Washington
Wyoming

NAUTIQUE



PERFORMANCE

If, for any reason your nearest dealer or the warehouse servicing your territory cannot satisfactorily resolve your problem or answer your questions, then please feel free to contact our Customer Service Department at the main offices of Correct Craft, Inc., either by telephone or by mail.

Dash Plaque Order Form

Dash Plaques are available for a price of \$6.00 for 2000 - 2002 boat models and \$10.00 for 1987 - 1999 boats. Please check off the shape that matches your boat plaque and mail along with you payment to:

Correct Craft, Attn: Tracy Cumbus-Umpierre, 6100 S. Orange Ave., Orlando, FL 32809
Allow 4 to 6 weeks for the custom plaque order to be processed, made and shipped.

Desired Saying: *(Please Print)* _____

Hull Number: _____

\$6.00 Boats made in 2003



\$6.00 Boats made in 2000 - 2002



\$10.00 Boats made in 1997 - 1999



\$10.00 Boats made in 1990 - 1996



\$10.00 Boats made in 1987 - 1989



Plaque will be shipped to: *(Please Print)*

Name: _____

Address: _____

City: _____ State: _____ Zip: _____

